



OM-254 170B

2012-09

Processes



Air Plasma Cutting
and Gouging

Description



Air Plasma Cutter

Spectrum[®] 625 X-TREME And XT40 Torch

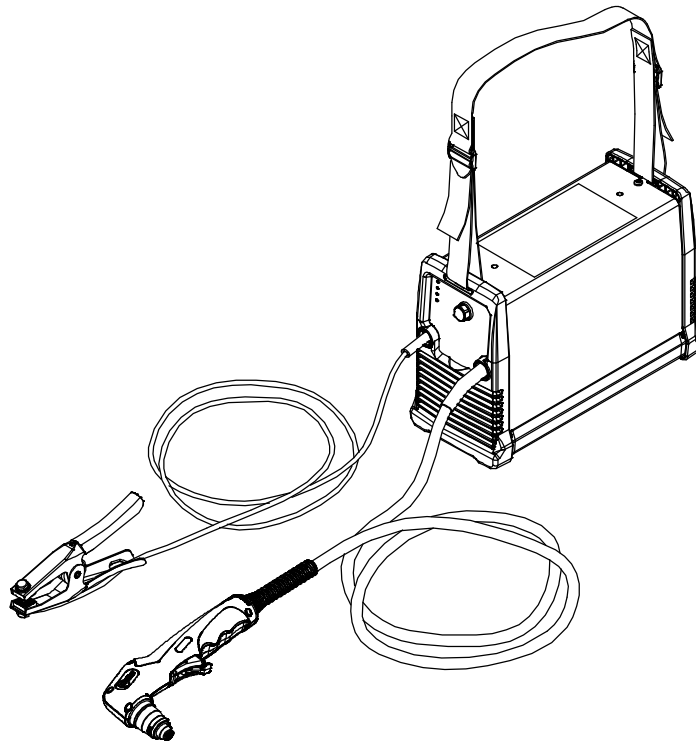

Visit our website at
www.MillerWelds.com

OWNER'S MANUAL

File: Plasma Cutters



From Miller to You

Thank you and congratulations on choosing Miller. Now you can get the job done and get it done right. We know you don't have time to do it any other way.

That's why when Niels Miller first started building arc welders in 1929, he made sure his products offered long-lasting value and superior quality. Like you, his customers couldn't afford anything less. Miller products had to be more than the best they could be. They had to be the best you could buy.

Today, the people that build and sell Miller products continue the tradition. They're just as committed to providing equipment and service that meets the high standards of quality and value established in 1929.

This Owner's Manual is designed to help you get the most out of your Miller products. Please take time to read the Safety precautions. They will help you protect yourself against potential hazards on the worksite.

We've made installation and operation quick and easy. With Miller you can count on years of reliable service with proper maintenance. And if for some reason the unit needs repair, there's a Troubleshooting section that will help you figure out what the problem is. The parts list will then help you to decide the exact part you may need to fix the problem. Warranty and service information for your particular model are also provided.



Miller is the first welding equipment manufacturer in the U.S.A. to be registered to the ISO 9001 Quality System Standard.

Miller Electric manufactures a full line of welders and welding related equipment. For information on other quality Miller products, contact your local Miller distributor to receive the latest full line catalog or individual specification sheets. **To locate your nearest distributor or service agency call 1-800-4-A-Miller, or visit us at www.MillerWelds.com on the web.**



Working as hard as you do – every power source from Miller is backed by the most hassle-free warranty in the business.



TABLE OF CONTENTS

| | |
|---|-----------|
| SECTION 1 – SAFETY PRECAUTIONS - READ BEFORE USING | 1 |
| 1-1. Symbol Usage | 1 |
| 1-2. Plasma Arc Cutting Hazards | 1 |
| 1-3. Additional Symbols For Installation, Operation, And Maintenance | 3 |
| 1-4. California Proposition 65 Warnings | 4 |
| 1-5. Principal Safety Standards | 4 |
| 1-6. EMF Information | 4 |
| SECTION 2 – CONSIGNES DE SÉCURITÉ – LIRE AVANT UTILISATION | 5 |
| 2-1. Signification des symboles | 5 |
| 2-2. Dangers liés au coupage à l'arc au plasma | 5 |
| 2-3. Dangers supplémentaires en relation avec l'installation, le fonctionnement et la maintenance | 7 |
| 2-4. Proposition californienne 65 Avertissements | 9 |
| 2-5. Principales normes de sécurité | 9 |
| 2-6. Informations relatives aux CEM | 9 |
| SECTION 3 – DEFINITIONS | 10 |
| 3-1. Manufacturer's Warning Label Definitions | 10 |
| 3-2. Miscellaneous Symbols And Definitions | 10 |
| SECTION 4 – INSTALLATION | 11 |
| 4-1. Specifications | 11 |
| 4-2. Torch Dimensions And Weight | 12 |
| 4-3. Duty Cycle And Overheating | 13 |
| 4-4. Power Source Dimensions And Weight | 13 |
| 4-5. Serial Number And Rating Label Location | 14 |
| 4-6. Selecting A Location | 14 |
| 4-7. Connecting Gas/Air Supply | 14 |
| 4-8. Connecting Work Clamp | 15 |
| 4-9. Electrical Service Guide | 15 |
| 4-10. Extension Cord Data | 15 |
| 4-11. Multi-Voltage Plug Adapter (MVP) Connection | 16 |
| 4-12. Connecting 120 Volt Input Power | 17 |
| 4-13. Connecting 1-Phase Input Power For 240 VAC | 18 |
| SECTION 5 – OPERATION | 20 |
| 5-1. Controls | 20 |
| 5-2. Mild Steel Recommended Cut Speed | 21 |
| 5-3. Trigger Safety Lock | 21 |
| 5-4. Plasma Cutting System Practices | 22 |
| 5-5. Sequence Of Cutting Operation | 23 |
| 5-6. Sequence Of Gouging Operation | 24 |
| 5-7. Sequence Of Piercing Operation | 25 |
| SECTION 6 – MAINTENANCE & TROUBLESHOOTING | 26 |
| 6-1. Routine Maintenance | 26 |
| 6-2. Wrapper Removal | 27 |
| 6-3. Checking Or Replacing Filter Element | 28 |
| 6-4. Status/Trouble Lights | 29 |
| 6-5. Checking Shield Cup Shutdown System | 30 |
| 6-6. Checking/Replacing Retaining Cup, Tip, And Electrode | 31 |
| 6-7. Troubleshooting Power Source | 32 |
| 6-8. Troubleshooting Torch | 33 |
| SECTION 7 – ELECTRICAL DIAGRAM | 34 |
| SECTION 8 – PARTS LIST | 36 |
| WARRANTY | |

SECTION 1 – SAFETY PRECAUTIONS - READ BEFORE USING

pom_2011-10

⚠ Protect yourself and others from injury — read, follow, and save these important safety precautions and operating instructions.

1-1. Symbol Usage



DANGER! – Indicates a hazardous situation which, if not avoided, will result in death or serious injury. The possible hazards are shown in the adjoining symbols or explained in the text.



Indicates a hazardous situation which, if not avoided, could result in death or serious injury. The possible hazards are shown in the adjoining symbols or explained in the text.

NOTICE – Indicates statements not related to personal injury.

1-2. Plasma Arc Cutting Hazards

⚠ The symbols shown below are used throughout this manual to call attention to and identify possible hazards. When you see the symbol, watch out, and follow the related instructions to avoid the hazard. The safety information given below is only a summary of the more complete safety information found in the Safety Standards listed in Section 1-5. Read and follow all Safety Standards.

⚠ Only qualified persons should install, operate, maintain, and repair this unit.

⚠ During operation, keep everybody, especially children, away.

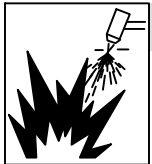

CUTTING can cause fire or explosion.

Hot metal and sparks blow out from the cutting arc. The flying sparks and hot metal, hot workpiece, and hot equipment can cause fires and burns. Check and be sure the area is safe before doing any cutting.

- Remove all flammables within 35 ft (10.7 m) of the cutting arc. If this is not possible, tightly cover them with approved covers.
- Do not cut where flying sparks can strike flammable material.
- Protect yourself and others from flying sparks and hot metal.
- Be alert that sparks and hot materials from cutting can easily go through small cracks and openings to adjacent areas.
- Watch for fire, and keep a fire extinguisher nearby.
- Be aware that cutting on a ceiling, floor, bulkhead, or partition can cause fire on the hidden side.
- Do not cut on containers that have held combustibles, or on closed containers such as tanks, drums, or pipes unless they are properly prepared according to AWS F4.1 and AWS A6.0 (see Safety Standards).
- Connect work cable to the work as close to the cutting area as practical to prevent cutting current from traveling long, possibly unknown paths and causing electric shock, sparks, and fire hazards.
- Do not use plasma cutter to thaw frozen pipes.
- Never cut containers with potentially flammable materials inside – they must be emptied and properly cleaned first.
- Do not cut where the atmosphere may contain flammable dust, gas, or liquid vapors (such as gasoline).
- Do not cut pressurized cylinders, pipes, or vessels.
- Wear oil-free protective garments such as leather gloves, heavy shirt, cuffless trousers, high shoes, and a cap.
- Do not locate unit on or over combustible surfaces.
- Remove any combustibles, such as a butane lighter or matches, from your person before doing any cutting.
- After completion of work, inspect area to ensure it is free of sparks, glowing embers, and flames.
- Use only correct fuses or circuit breakers. Do not oversize or bypass them.
- Follow requirements in OSHA 1910.252 (a) (2) (iv) and NFPA 51B for hot work and have a fire watcher and extinguisher nearby.

 Indicates special instructions.



This group of symbols means Warning! Watch Out! ELECTRIC SHOCK, MOVING PARTS, and HOT PARTS hazards. Consult symbols and related instructions below for necessary actions to avoid the hazards.



ELECTRIC SHOCK can kill.

Touching live electrical parts can cause fatal shocks or severe burns. The torch and work circuit are electrically live whenever the output is on. The input power circuit and machine internal circuits are also live when power is on. Plasma arc cutting requires higher voltages than welding to start and maintain the arc (200 to 400 volts dc are common), but may also use torches designed with safety interlock systems which turn off the machine when the shield cup is loosened or if tip touches electrode inside the nozzle. Incorrectly installed or improperly grounded equipment is a hazard.

- Do not touch live electrical parts.
- Wear dry, hole-free insulating gloves and body protection.
- Insulate yourself from work and ground using dry insulating mats or covers big enough to prevent any physical contact with the work or ground.
- Do not touch torch parts if in contact with the work or ground.
- Turn off power before checking, cleaning, or changing torch parts.
- Disconnect input power before installing or servicing this equipment. Lockout/tagout input power according to OSHA CFR 1910.147 (see Safety Standards).
- Properly install, ground, and operate this equipment according to its Owner's Manual and national, state, and local codes.
- Check and be sure that input power cord ground wire is properly connected to ground terminal in disconnect box or that cord plug is connected to a properly grounded receptacle outlet – always verify the supply ground.
- When making input connections, attach proper grounding conductor first.
- Keep cords dry, free of oil and grease, and protected from hot metal and sparks.
- Frequently inspect input power cord for damage or bare wiring – replace cord immediately if damaged – bare wiring can kill.
- Turn off all equipment when not in use.
- Inspect and replace any worn or damaged torch cable leads.
- Do not wrap torch cable around your body.
- Ground the workpiece to a good electrical (earth) ground if required by codes.
- Use only well-maintained equipment. Repair or replace damaged parts at once.
- Wear a safety harness if working above floor level.
- Keep all panels and covers securely in place.
- Do not bypass or try to defeat the safety interlock systems.
- Use only torch(es) specified in Owner's Manual.
- Keep away from torch tip and pilot arc when trigger is pressed.
- Clamp work cable with good metal-to-metal contact to workpiece (not piece that will fall away) or worktable as near the cut as practical.
- Insulate work clamp when not connected to workpiece to prevent contact with any metal object.



ELECTRIC SHOCK can kill.

SIGNIFICANT DC VOLTAGE exists in inverter power sources AFTER the removal of input power.

- Turn Off unit, disconnect input power, check voltage on input capacitors, and be sure it is near zero (0) volts before touching any parts. Check capacitors according to instructions in Maintenance Section of Owner's Manual or Technical Manual before touching any parts.

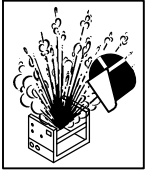

EXPLODING PARTS can injure.

- On inverter power sources, failed parts can explode or cause other parts to explode when power is applied. Always wear a face shield and long sleeves when servicing inverters.

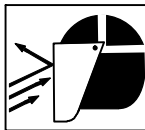

FLYING SPARKS can injure.

Sparks and hot metal blow out from the cutting arc. Chipping and grinding cause flying metal.

- Wear approved face shield or safety goggles with side shields.
- Wear proper body protection to protect skin.
- Wear flame-resistant ear plugs or ear muffs to prevent sparks from entering ears.

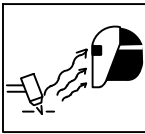





ARC RAYS can burn eyes and skin.

Arc rays from the cutting process produce intense visible and invisible (ultraviolet and infrared) rays that can burn eyes and skin.

- Wear face protection (helmet or shield) with a proper shade of filter lenses to protect your face and eyes from arc rays and sparks when cutting or watching. ANSI Z49.1 (see Safety Standards) suggests a No. 9 shade (with No. 8 as minimum) for all cutting currents less than 300 amperes. Z49.1 adds that lighter filter shades may be used when the arc is hidden by the workpiece. As this is normally the case with low current cutting, the shades suggested in Table 1 are provided for the operator's convenience.
- Wear approved safety glasses with side shields under your helmet or shield.
- Use protective screens or barriers to protect others from flash, glare and sparks; warn others not to watch the arc.
- Wear protective clothing made from durable, flame-resistant material (leather, heavy cotton, or wool) and foot protection.

Table 1. Eye Protection For Plasma Arc Cutting

| Current Level In Amperes | Minimum Shade Number | |
|--------------------------|---|----|
| Below 20 |  | #4 |
| 20 – 40 |  | #5 |
| 40 – 60 |  | #6 |
| 60 – 100 |  | #8 |

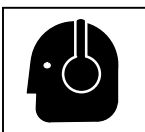

NOISE can damage hearing.

Prolonged noise from some cutting applications can damage hearing if levels exceed limits specified by OSHA (see Safety Standards).

- Use approved ear plugs or ear muffs if noise level is high.
- Warn others nearby about noise hazard.



FUMES AND GASES can be hazardous.

Cutting produces fumes and gases. Breathing these fumes and gases can be hazardous to your health.

- Keep your head out of the fumes. Do not breathe the fumes.
- If inside, ventilate the area and/or use local forced ventilation at the arc to remove cutting fumes and gases.
- If ventilation is poor, wear an approved air-supplied respirator.
- Read and understand the Material Safety Data Sheets (MSDSs) and the manufacturer's instruction for metals to be cut, coatings, and cleaners.
- Work in a confined space only if it is well ventilated, or while wearing an air-supplied respirator. Fumes from cutting and oxygen depletion can alter air quality causing injury or death. Be sure the breathing air is safe.
- Do not cut in locations near degreasing, cleaning, or spraying operations. The heat and rays of the arc can react with vapors to form highly toxic and irritating gases.
- Do not cut on coated metals, such as galvanized, lead, or cadmium plated steel, unless the coating is removed from the cutting area, the area is well ventilated, and while wearing an air-supplied respirator. The coatings and any metals containing these elements can give off toxic fumes when cut.
- Do not cut containers with toxic or reactive materials inside or containers that have held toxic or reactive materials – they must be emptied and properly cleaned first.

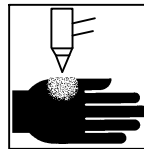

PLASMA ARC can injure.

The heat from the plasma arc can cause serious burns. The force of the arc adds greatly to the burn hazard. The intensely hot and powerful arc can quickly cut through gloves and tissue.

- Keep away from the torch tip.
- Do not grip material near the cutting path.
- The pilot arc can cause burns – keep away from torch tip when trigger is pressed.
- Wear proper flame-retardant clothing covering all exposed body areas.
- Point torch away from your body and toward work when pressing the torch trigger – pilot arc comes on immediately.
- Turn off power source and disconnect input power before disassembling torch or changing torch parts.
- Use only torch(es) specified in the Owner's Manual.

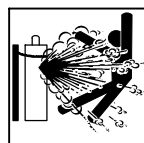

CYLINDERS can explode if damaged.

Compressed gas cylinders contain gas under high pressure. If damaged, a cylinder can explode. Since gas cylinders are normally part of metalworking processes, be sure to treat them carefully.

- Protect compressed gas cylinders from excessive heat, mechanical shocks, physical damage, slag, open flame, sparks, and arcs.
- Install and secure cylinders in an upright position by chaining them to a stationary support or equipment cylinder rack to prevent falling or tipping.
- Keep cylinders away from any cutting or other electrical circuits.
- Never allow electrical contact between a plasma arc torch and a cylinder.
- Never cut on a pressurized cylinder – explosion will result.
- Use only correct compressed gas cylinders, regulators, hoses, and fittings designed for the specific application; maintain them and associated parts in good condition.
- Turn face away from valve outlet when opening cylinder valve.
- Keep protective cap in place over valve except when cylinder is in use or connected for use.
- Use the right equipment, correct procedures, and sufficient number of persons to lift and move cylinders.
- Read and follow instructions on compressed gas cylinders, associated equipment, and Compressed Gas Association (CGA) publication P-1 listed in Safety Standards.

1-3. Additional Symbols For Installation, Operation, And Maintenance



HOT PARTS can burn.

- Do not touch hot parts bare handed.
- Allow cooling period before working on equipment.
- To handle hot parts, use proper tools and/or wear heavy, insulated welding gloves and clothing to prevent burns.



MOVING PARTS can injure.

- Keep away from moving parts such as fans.
- Keep all doors, panels, covers, and guards closed and securely in place.
- Have only qualified persons remove doors, panels, covers, or guards for maintenance and troubleshooting as necessary.
- Reinstall doors, panels, covers, or guards when maintenance is finished and before reconnecting input power.

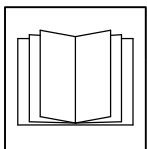

READ INSTRUCTIONS.

- Read and follow all labels and the Owner's Manual carefully before installing, operating, or servicing unit. Read the safety information at the beginning of the manual and in each section.
- Use only genuine replacement parts from the manufacturer.
- Perform maintenance and service according to the Owner's Manuals, industry standards, and national, state, and local codes.

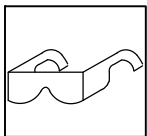

FLYING METAL or DIRT can injure eyes.

- Wear safety glasses with side shields or wear face shield.



ELECTRIC AND MAGNETIC FIELDS (EMF) can affect Implanted Medical Devices.

- Wearers of Pacemakers and other Implanted Medical Devices should keep away.
- Implanted Medical Device wearers should consult their doctor and the device manufacturer before going near arc welding, spot welding, gouging, plasma arc cutting, or induction heating operations.

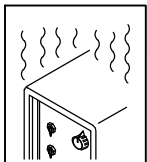

OVERUSE can cause OVERHEATING.

- Allow cooling period; follow rated duty cycle.
- Reduce amperage (thickness) or reduce duty cycle before starting to cut again.



EXPLODING HYDROGEN hazard.

- When cutting aluminum underwater or with the water touching the underside of the aluminum, free hydrogen gas may collect under the work-piece.
- See your cutting engineer and water table instructions for help.

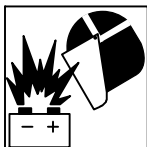

BATTERY EXPLOSION can injure.

- Do not use plasma cutter to charge batteries or jump start vehicles unless it has a battery charging feature designed for this purpose.

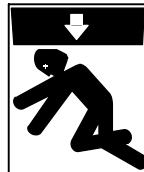

FALLING EQUIPMENT can injure.

- Use lifting eye to lift unit only, NOT running gear, gas cylinders, or any other accessories.
- Use equipment of adequate capacity to lift unit.
- If using lift forks to move unit, be sure forks are long enough to extend beyond opposite side of unit.
- Keep equipment (cables and cords) away from moving vehicles when working from an aerial location.
- Follow the guidelines in the Applications Manual for the Revised NIOSH Lifting Equation (Publication No. 94-110) when manually lifting heavy parts or equipment.



FIRE OR EXPLOSION hazard.

- Do not locate unit on, over, or near combustible surfaces.
- Do not install unit near flammables.
- Do not overload building wiring – be sure power supply system is properly sized, rated, and protected to handle this unit.

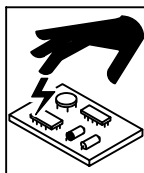

STATIC (ESD) can damage PC boards.

- Put on grounded wrist strap BEFORE handling boards or parts.
- Use proper static-proof bags and boxes to store, move, or ship PC boards.

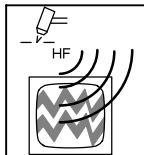

H.F. RADIATION can cause interference.

- High frequency (H.F.) can interfere with radio navigation, safety services, computers, and communications equipment.
- Have only qualified persons familiar with electronic equipment perform this installation.
- The user is responsible for having a qualified electrician promptly correct any interference problem resulting from the installation.
- If notified by the FCC about interference, stop using the equipment at once.
- Have the installation regularly checked and maintained.
- Keep high-frequency source doors and panels tightly shut, keep spark gaps at correct setting, and use grounding and shielding to minimize the possibility of interference.



ARC CUTTING can cause interference.

- Electromagnetic energy can interfere with sensitive electronic equipment such as computers and computer-driven equipment such as robots.
- To reduce possible interference, keep cables as short as possible, close together, and down low, such as on the floor.
- Locate cutting operation 100 meters from any sensitive electronic equipment.
- Be sure this cutting power source is installed and grounded according to this manual.
- If interference still occurs, the user must take extra measures such as moving the machine, using shielded cables, using line filters, or shielding the work area.

1-4. California Proposition 65 Warnings

 Welding or cutting equipment produces fumes or gases which contain chemicals known to the State of California to cause birth defects and, in some cases, cancer. (California Health & Safety Code Section 25249.5 et seq.)

 This product contains chemicals, including lead, known to the state of California to cause cancer, birth defects, or other reproductive harm. *Wash hands after use.*

1-5. Principal Safety Standards

Safety in Welding, Cutting, and Allied Processes, ANSI Standard Z49.1, is available as a free download from the American Welding Society at <http://www.aws.org> or purchased from Global Engineering Documents (phone: 1-877-413-5184, website: www.global.ihs.com).

Recommended Practices for Plasma Arc Cutting and Gouging, American Welding Society Standard AWS C5.2, from Global Engineering Documents (phone: 1-877-413-5184, website: www.global.ihs.com).

Safe Practices for the Preparation of Containers and Piping for Welding and Cutting, American Welding Society Standard AWS F4.1, from Global Engineering Documents (phone: 1-877-413-5184, website: www.global.ihs.com).

Safe Practices for Welding and Cutting Containers that have Held Combustibles, American Welding Society Standard AWS A6.0, from Global Engineering Documents (phone: 1-877-413-5184, website: www.global.ihs.com).

National Electrical Code, NFPA Standard 70, from National Fire Protection Association, Quincy, MA 02269 (phone: 1-800-344-3555, website: www.nfpa.org and www.sparky.org).

Safe Handling of Compressed Gases in Cylinders, CGA Pamphlet P-1, from Compressed Gas Association, 14501 George Carter Way, Suite 103, Chantilly, VA 20151 (phone: 703-788-2700, website: www.cganet.com).

Safety in Welding, Cutting, and Allied Processes, CSA Standard W117.2, from Canadian Standards Association, Standards Sales, 5060 Spectrum Way, Suite 100, Ontario, Canada L4W 5NS (phone: 800-463-6727, website: www.csa-international.org).

Safe Practice For Occupational And Educational Eye And Face Protection, ANSI Standard Z87.1, from American National Standards Institute, 25 West 43rd Street, New York, NY 10036 (phone: 212-642-4900, website: www.ansi.org).

Standard for Fire Prevention During Welding, Cutting, and Other Hot Work, NFPA Standard 51B, from National Fire Protection Association, Quincy, MA 02269 (phone: 1-800-344-3555, website: www.nfpa.org).

OSHA, Occupational Safety and Health Standards for General Industry, Title 29, Code of Federal Regulations (CFR), Part 1910, Subpart Q, and Part 1926, Subpart J, from U.S. Government Printing Office, Superintendent of Documents, P.O. Box 371954, Pittsburgh, PA 15250-7954 (phone: 1-866-512-1800) (there are 10 OSHA Regional Offices—phone for Region 5, Chicago, is 312-353-2220, website: www.osha.gov).

Applications Manual for the Revised NIOSH Lifting Equation, The National Institute for Occupational Safety and Health (NIOSH), 1600 Clifton Rd, Atlanta, GA 30333 (phone: 1-800-232-4636, website: www.cdc.gov/NIOSH).

1-6. EMF Information

Electric current flowing through any conductor causes localized electric and magnetic fields (EMF). Welding current creates an EMF field around the welding circuit and welding equipment. EMF fields may interfere with some medical implants, e.g. pacemakers. Protective measures for persons wearing medical implants have to be taken. For example, restrict access for passers—by or conduct individual risk assessment for welders. All welders should use the following procedures in order to minimize exposure to EMF fields from the welding circuit:

1. Keep cables close together by twisting or taping them, or using a cable cover.
2. Do not place your body between welding cables. Arrange cables to one side and away from the operator.
3. Do not coil or drape cables around your body.

4. Keep head and trunk as far away from the equipment in the welding circuit as possible.
5. Connect work clamp to workpiece as close to the weld as possible.
6. Do not work next to, sit or lean on the welding power source.
7. Do not weld whilst carrying the welding power source or wire feeder.

About Implanted Medical Devices:

Implanted Medical Device wearers should consult their doctor and the device manufacturer before performing or going near arc welding, spot welding, gouging, plasma arc cutting, or induction heating operations. If cleared by your doctor, then following the above procedures is recommended.

SECTION 2 – CONSIGNES DE SÉCURITÉ – LIRE AVANT UTILISATION

pom_2011-10fre

! Pour écarter les risques de blessure pour vous-même et pour autrui — lire, appliquer et ranger en lieu sûr ces consignes relatives aux précautions de sécurité et au mode opératoire.

2-1. Signification des symboles



DANGER! – Indique une situation dangereuse qui si on l'évite pas peut donner la mort ou des blessures graves. Les dangers possibles sont montrés par les symboles joints ou sont expliqués dans le texte.



Indique une situation dangereuse qui si on l'évite pas peut donner la mort ou des blessures graves. Les dangers possibles sont montrés par les symboles joints ou sont expliqués dans le texte.

NOTE – Indique des déclarations pas en relation avec des blessures personnelles.

 Indique des instructions spécifiques.



Ce groupe de symboles veut dire Avertissement! Attention! DANGER DE CHOC ÉLECTRIQUE, PIÈCES EN MOUVEMENT, et PIÈCES CHAUDES. Consulter les symboles et les instructions ci-dessous y afférant pour les actions nécessaires afin d'éviter le danger.

2-2. Dangers liés au coupage à l'arc au plasma



Les symboles présentés ci-après sont utilisés tout au long du présent manuel pour attirer votre attention et identifier les risques de danger. Lorsque vous voyez un symbole, soyez vigilant et suivez les directives mentionnées afin d'éviter tout danger. Les consignes de sécurité présentées ci-après ne font que résumer l'information contenue dans les normes de sécurité énumérées à la section 1-5. Veuillez lire et respecter toutes ces normes de sécurité.



L'installation, l'utilisation, l'entretien et les réparations ne doivent être confiés qu'à des personnes qualifiées.



Au cours de l'utilisation, tenir toute personne à l'écart et plus particulièrement les enfants.

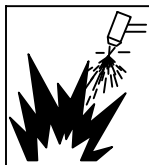

LE COUPAGE présente un risque de feu ou d'explosion.

Des particules de métal chaud et des étincelles peuvent jaillir de la pièce au moment du coupage. Les étincelles et le métal chaud, la pièce à couper chauffée et l'équipement chaud peuvent causer un feu ou des brûlures. Avant de commencer à travailler, assurez-vous que l'endroit est sécurisé.

- Déplacez toute matière inflammable se trouvant à l'intérieur d'un périmètre de 10,7 m (35 pi) de la pièce à couper. Si cela est impossible, vous devez les couvrir avec des housses approuvées et bien ajustées.
- Ne coupez pas dans un endroit où des étincelles pourraient atteindre des matières inflammables.
- Protégez-vous, ainsi que toute autre personne travaillant sur les lieux, contre les étincelles et le métal chaud.
- Assurez-vous qu'aucune étincelle ni particule de métal ne peut se glisser dans de petites fissures ou tomber dans d'autres pièces.
- Afin d'éliminer tout risque de feu, soyez vigilant et gardez toujours un extincteur à la portée de la main.
- Si vous coupez sur un plafond, un plancher ou une cloison, soyez conscient que cela peut entraîner un feu de l'autre côté.
- Ne pas effectuer le soudage sur des contenants fermés tels que des réservoirs, tambours, ou conduites, à moins qu'ils n'aient été préparés correctement conformément à AWS F4.1 et AWS A6.0 (voir les Normes de Sécurité).
- Ne coupez pas sur un contenant fermé tel qu'un réservoir ou un bidon.
- Fixez le câble de masse sur la pièce à couper, le plus près possible de la zone à couper afin de prévenir que le courant de coupage ne prenne une trajectoire inconnue ou longue et ne cause ainsi une décharge électrique, d'étincelles ou un feu.

- Ne pas utiliser le coupeur plasma pour dégeler des conduites gelées.
- Ne coupez jamais des contenants qui peuvent contenir des matières inflammables. Vous devez en premier lieu les vider et les nettoyer convenablement.
- Ne coupez pas quand l'atmosphère peut contenir des poussières, gaz ou vapeurs (comme l'essence) inflammables.
- Ne coupez pas dans un endroit où l'atmosphère risque de contenir de la poussière ou des vapeurs explosives.
- Ne coupez pas de bouteilles, de tuyaux ou de contenants pressurisés.
- Portez des vêtements de protection exempts d'huile tels que des gants en cuir, une veste résistante, des pantalons sans revers, des bottes et un casque.
- Ne placez pas le poste sur une surface combustible ou au-dessus de celle-ci.
- Une fois le travail achevé, assurez-vous qu'il ne reste aucune trace d'étincelles incandescentes ni de flammes.
- Utiliser exclusivement des fusibles ou coupe-circuits appropriés. Ne pas augmenter leur puissance; ne pas les ponter.
- Avant le coupage, retirez tout combustible de vos poches, par exemple un briquet au butane ou des allumettes.



UN CHOC ÉLECTRIQUE peut tuer.

Touching live electrical parts can cause fatal shocks or severe burns. The torch and work circuit are electrically live whenever the output is on. The input power circuit and machine internal circuits are also live when power is on. Le coupage plasma nécessite

des tensions plus importantes que le soudage pour amorcer et maintenir l'arc (200 à 400VDC est typique), mais peut être utilisé avec des torches équipées de systèmes de verrouillage de sécurité qui arrêtent la machine en cas de buse desserrée ou si l'électrode touche la tuyère. Incorrectly installed or improperly grounded equipment is a hazard.

- Ne touchez pas aux pièces électriques sous tension.
- Portez des gants isolants et des vêtements de protection secs et sans trous.
- Isolez-vous de la pièce à couper et du sol en utilisant des housses ou des tapis assez grands afin d'éviter tout contact physique avec la pièce à couper ou le sol.
- Ne touchez pas aux pièces du chalumeau si vous êtes en contact avec la pièce à couper ou le sol.
- Mettez l'appareil hors tension avant d'effectuer la vérification, le nettoyage ou le changement d'une pièce du chalumeau.

- Coupez l'alimentation d'entrée avant d'installer l'appareil ou d'effectuer l'entretien. Verrouillez ou étiquetez la sortie d'alimentation selon la norme OSHA 29 CFR 1910.147 (reportez-vous aux Principales normes de sécurité).
- Installer le poste correctement et le mettre à la terre convenablement selon les consignes du manuel de l'opérateur et les normes nationales, départementales et locales.
- Assurez-vous que le fil de terre du cordon d'alimentation est correctement relié à la borne de terre dans la boîte de coupure ou que la fiche du cordon est branchée à une prise correctement mise à la terre – vous devez toujours vérifier la mise à la terre.
- Avant d'effectuer les connexions d'alimentation, vous devez relier le bon fil de terre.
- Les câbles doivent être exempts d'humidité, d'huile et de graisse; protégez-les contre les étincelles et les pièces métalliques chaudes.
- Vérifiez fréquemment le cordon d'alimentation afin de vous assurer qu'il n'est pas altéré ou à nu, remplacez-le immédiatement s'il l'est. Un fil à nu peut entraîner la mort.
- L'équipement doit être hors tension lorsqu'il n'est pas utilisé.
- Vérifiez et remplacez les cosses du câble du chalumeau si elles sont usées ou altérées.
- Le câble du chalumeau ne doit pas s'enrouler autour de votre corps.
- Si les normes le stipulent, la pièce à couper doit être mise à la terre.
- Utilisez uniquement de l'équipement en bonne condition. Réparez ou remplacez immédiatement toute pièce altérée.
- Portez un harnais de sécurité si vous devez travailler au-dessus du sol.
- Assurez-vous que tous les panneaux et couvercles sont correctement en place.
- N'essayez pas d'aller à l'encontre des systèmes de verrouillage de sécurité ou de les contourner.
- Utilisez uniquement le ou les chalumeaux recommandés dans le manuel de l'opérateur.
- N'approchez pas le tube du chalumeau et l'arc pilote lorsque la gâchette est enfoncée.
- Le câble de masse doit être pincé correctement sur la pièce à couper, métal contre métal (et non de telle sorte qu'il puisse se détacher), ou sur la table de travail le plus près possible de la ligne de coupure.
- Isoler la pince de masse quand pas mis à la pièce pour éviter le contact avec tout objet métallique.



DÉCHARGES ÉLECTRIQUES potentiellement mortelles.

Il reste une TENSION DC NON NÉGLIGEABLE dans les sources de soudage onduleur UNE FOIS l'alimentation coupée.

- Mettre l'unité hors tension, mesurer la tension des condensateurs d'entrée et s'assurer qu'elle est pratiquement nulle avant de toucher à l'une quelconque des pièces. Mesurer cette tension conformément aux directives énoncées à la section Entretien du manuel de l'utilisateur ou du manuel technique avant de toucher à l'une quelconque des pièces.

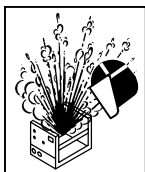

Risque de blessure en cas D'EXPLOSION DES PIÈCES.

- Mise sous tension, toute pièce défectueuse des sources d'alimentation de l'inverseur peut exploser ou faire exploser d'autres pièces. Pour entretenir les inverseurs, toujours porter un masque protecteur et un vêtement à manches longues.

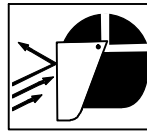

LES ÉTINCELLES PROJÉTÉES peuvent provoquer des blessures.

Le coupage plasma produit des étincelles et projections de métal à très haute température. Lorsque la pièce refroidit, du laitier peut se former.

- Portez une visière ou des lunettes de sécurité avec des écrans latéraux approuvés.
- Portez des vêtements de protection adéquats afin de protéger votre peau.
- Ayez recours à des protège-tympons ou à un serre-tête ignifuges afin d'éviter que les étincelles n'entrent dans vos oreilles.

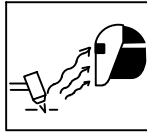





LES RAYONS D'ARC peuvent entraîner des brûlures aux yeux et à la peau.

Les rayons d'arc provenant du procédé de coupage produisent des rayons visibles et invisibles intenses (ultraviolets et infrarouges) qui peuvent entraîner des brûlures aux yeux et à la peau.

- Une protection faciale (casque ou masque) avec des lunettes filtrantes de teinte adéquate est indispensable pour protéger le visage et les yeux des rayonnements de l'arc et des étincelles pendant la découpe ou en regardant simplement ANSI Z49.1 (reportez-vous aux Principales normes de sécurité) suggère d'utiliser un filtre de teinte n° 9 (n° 8 étant le minimum) pour tout travail de coupage faisant appel à un courant de moins de 300 A. On mentionne également dans la norme Z49.1 qu'un filtre plus faible peut être utilisé lorsque l'arc est caché par la pièce à couper. Comme cela est habituellement le cas pour les travaux de coupage à faible courant, les teintes énumérées au tableau 1 sont fournies à titre d'information pour l'opérateur.
- Porter des lunettes de sécurité à coques latérales sous votre casque ou écran facial.
- Ayez recours à des écrans protecteurs ou à des rideaux pour protéger les autres contre les rayonnements, les étincelles et les éblouissements; prévenez toute personne sur les lieux de ne pas regarder l'arc.
- Portez des vêtements confectionnés avec des matières résistantes et ignifuges (cuir, coton lourd ou laine) et des bottes de protection.

Tableau 1. Protection des yeux pour le coupage au plasma d'arc

| Intensité de courant en ampères | Filtre de teinte (minimum) | |
|---------------------------------|---|-------|
| Moins de 20 |  | no. 4 |
| 20 – 40 |  | no. 5 |
| 40 – 60 |  | no. 6 |
| 60 – 100 |  | no. 8 |

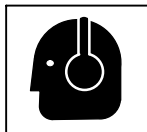

LE BRUIT peut endommager l'ouïe.

Certaines applications de coupage produisent un bruit constant, ce qui peut endommager l'ouïe si le niveau sonore dépasse les limites permises par l'OSHA (reportez-vous aux Principales normes de sécurité).

- Utilisez des protège-tympons ou un serre-tête antibruit si le niveau sonore est élevé.
- Prévenez toute personne sur les lieux du danger relié au bruit.



LES FUMÉES ET LES GAZ peuvent être dangereux.

Le coupage produit des vapeurs et des gaz. Respirer ces vapeurs et ces gaz peut être dangereux pour la santé.

- Ne mettez pas votre tête au-dessus des vapeurs. Ne respirez pas ces vapeurs.

- Si vous êtes à l'intérieur au moment du coupage, ventilez la pièce ou ayez recours à une ventilation aspirante installée près de l'arc pour évacuer les vapeurs et les gaz.
- Si la ventilation est médiocre, utilisez un respirateur anti-vapeurs approuvé.
- Lire et comprendre les spécifications de sécurité des matériaux (MSDS) et les instructions du fabricant concernant les métaux, les consommables, les revêtements, les nettoyeurs et les dégraissants.
- Travaillez dans un espace restreint uniquement s'il est bien ventilé ou si vous portez un respirateur anti-vapeurs. Les vapeurs causées par le coupage et l'épuisement de l'oxygène peuvent altérer la qualité de l'air et entraîner des blessures ou la mort. Assurez-vous que l'air ambiant est sain pour la santé.
- Ne coupez pas dans un endroit près d'opérations de décapage, de nettoyage ou de vaporisation. La chaleur et les rayons d'arc peuvent réagir avec les vapeurs et former des gaz hautement toxiques et irritants.
- Ne coupez pas des métaux enrobés tels que des métaux galvanisés, contenant du plomb ou de l'acier plaqué au cadmium, à moins que l'enrobage ne soit ôté de la surface du métal à couper, que l'endroit où vous travaillez ne soit bien ventilé, ou que vous ne portiez un respirateur anti-vapeurs. Les enrobages ou tous métaux qui contiennent ces éléments peuvent créer des vapeurs toxiques s'ils sont coupés.
- Ne coupez pas de contenants qui renferment ou ont renfermés des matières toxiques ou réactives – vous devez en premier lieu les vider et les nettoyer convenablement.

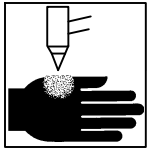

L'ARC PLASMA peut provoquer des blessures.

La chaleur dégagée par le plasma d'arc peut entraîner de sérieuses brûlures. La force de l'arc est un facteur qui s'ajoute au danger de brûlures. La chaleur intense et la puissance de l'arc peuvent rapidement passer au travers de gants et de tissus.

- N'approchez pas le tube du chalumeau.
- Ne saisissez pas la pièce à couper près de la ligne de coupage.
- L'arc pilote peut causer des brûlures – n'approchez pas le tube du chalumeau lorsque vous avez appuyé sur le gâchette.
- Portez des vêtements de protection adéquats qui recouvrent tout votre corps.

- Ne pointez pas le chalumeau en direction de votre corps ni de la pièce à couper lorsque vous appuyez sur la gâchette – l'arc pilote s'allume automatiquement.
- Mettez l'alimentation hors tension et débranchez le cordon d'alimentation avant de démonter le chalumeau ou de changer une pièce du chalumeau.
- Utilisez uniquement le ou les chalumeaux recommandés dans le manuel de l'opérateur.

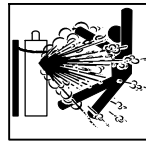

LES BOUTEILLES peuvent exploser si elles sont endommagées.

Les bouteilles de gaz comprimé contiennent du gaz sous haute pression. Si une bouteille est endommagée, elle peut exploser. Puisque les bouteilles de gaz font habituellement partie d'un processus de travail des métaux, assurez-vous de les manipuler correctement.

- Protégez les bouteilles de gaz comprimé contre la chaleur excessive, les chocs mécaniques, des dommages physiques, le laitier, la flamme, les étincelles et l'arc.
- Installez et attachez les bouteilles dans la position verticale à l'aide d'une chaîne, sur un support stationnaire ou un châssis porte-bouteille afin de prévenir qu'elles ne tombent ou ne basculent.
- Les bouteilles ne doivent pas être près de la zone de coupage ni de tout autre circuit électrique.
- Un contact électrique ne doit jamais se produire entre un chalumeau de plasma d'arc et une bouteille.
- Ne coupez jamais sur une bouteille pressurisée – une explosion en résulterait.
- Utilisez uniquement des bouteilles de gaz comprimé, des détendeurs, des boyaux et des raccords conçus pour l'application déterminée. Gardez-les, ainsi que toute autre pièce associée, en bonne condition.
- Détournez votre visage du détendeur-régulateur lorsque vous ouvrez la soupape de la bouteille.
- Le couvercle du détendeur doit toujours être en place, sauf lorsque vous utilisez la bouteille ou qu'elle est reliée pour usage ultérieur.
- Utilisez les équipements corrects, les bonnes procédures et suffisamment de personnes pour soulever et déplacer les bouteilles.
- Lire et suivre les instructions sur les bouteilles de gaz comprimé, l'équipement connexe et le dépliant P-1 de la CGA (Compressed Gas Association) mentionné dans les principales normes de sécurité.

2-3. Dangers supplémentaires en relation avec l'installation, le fonctionnement et la maintenance



LES PIÈCES CHAUDES peuvent provoquer des brûlures.

- Ne pas toucher des parties chaudes à mains nues.
- Prévoir une période de refroidissement avant d'utiliser l'équipement.
- Ne pas toucher aux pièces chaudes, utiliser les outils recommandés et porter des gants de soudage et des vêtements épais pour éviter les brûlures.



Les PIÈCES MOBILES peuvent provoquer des blessures.

- S'abstenir de toucher des organes mobiles tels que des ventilateurs.
- Maintenir fermés et verrouillés les portes, panneaux, recouvrements et dispositifs de protection.
- Lorsque cela est nécessaire pour des travaux d'entretien et de dépannage, faire retirer les portes, panneaux, recouvrements ou dispositifs de protection uniquement par du personnel qualifié.
- Remettre les portes, panneaux, recouvrements ou dispositifs de protection quand l'entretien est terminé et avant de rebrancher l'alimentation électrique.

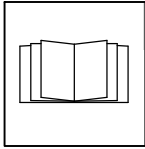

LIRE LES INSTRUCTIONS.

- Lire et appliquer les instructions sur les étiquettes et le Mode d'emploi avant l'installation, l'utilisation ou l'entretien de l'appareil. Lire les informations de sécurité au début du manuel et dans chaque section.
- N'utiliser que les pièces de rechange recommandées par le constructeur.
- Effectuer l'entretien en respectant les manuels d'utilisation, les normes industrielles et les codes nationaux, d'état et locaux.

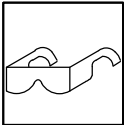

DES PIÈCES DE METAL ou DES SALETES peuvent provoquer des blessures dans les yeux.

- Porter des lunettes de sécurité avec écrans latéraux ou un écran facial.



Les CHAMPS ÉLECTROMAGNÉTIQUES (CEM) peuvent affecter les implants médicaux.

- Les porteurs de stimulateurs cardiaques et autres implants médicaux doivent rester à distance.
- Les porteurs d'implants médicaux doivent consulter leur médecin et le fabricant du dispositif avant de s'approcher de la zone où se déroule du soudage à l'arc, du soudage par points, du gougeage, de la découpe plasma ou une opération de chauffage par induction.

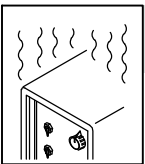

L'EMPLOI EXCESSIF peut SURCHAUFFER L'ÉQUIPEMENT.

- Prévoir une période de refroidissement; respecter le cycle opératoire nominal.
- Réduire l'ampérage (épaisseur) avant de continuer à couper ou réduire le facteur de marche.



Danger D'EXPLOSION D'HYDROGÈNE.

- Lors du coupage d'aluminium partiellement ou totalement immergé dans l'eau, de l'hydrogène libre peut s'accumuler sous la pièce.
- Consultez votre ingénieur de coupage et les instructions de la table de coupage.



L'EXPLOSION DE LA BATTERIE peut provoquer des blessures.

- Ne pas utiliser le découpeur plasma pour charger des batteries ou faire démarrer des véhicules à l'aide de câbles de démarrage, sauf si l'appareil dispose d'une fonctionnalité de charge de batterie destinée à cet usage.



LA CHUTE DE L'ÉQUIPEMENT peut provoquer des blessures.

- Utiliser l'anneau de levage uniquement pour soulever l'appareil, NON PAS le chariot, les bouteilles de gaz ou tout autre accessoire.
- Utiliser un engin d'une capacité appropriée pour soulever l'appareil.
- En utilisant des fourches de levage pour déplacer l'unité, s'assurer que les fourches sont suffisamment longues pour dépasser du côté opposé de l'appareil.
- Tenir l'équipement (câbles et cordons) à distance des véhicules mobiles lors de toute opération en hauteur.
- Suivre les consignes du Manuel des applications pour l'équation de levage NIOSH révisée (Publication N°94-110) lors du levage manuel de pièces ou équipements lourds.



Risque D'INCENDIE OU D'EXPLOSION.

- Ne pas placer l'appareil sur, au-dessus ou à proximité de surfaces inflammables.
- Ne pas installer l'appareil à proximité de produits inflammables
- Ne pas surcharger l'installation électrique – s'assurer que l'alimentation est correctement dimensionnée et protégée avant de mettre l'appareil en service.

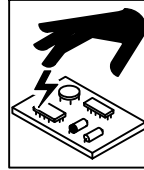

LES CHARGES ÉLECTROSTATIQUES peuvent endommager les circuits imprimés.

- Etablir la connexion avec la barrette de terre avant de manipuler des cartes ou des pièces.
- Utiliser des pochettes et des boîtes antistatiques pour stocker, déplacer ou expédier des cartes PC.

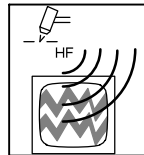

LE RAYONNEMENT HAUTE FRÉQUENCE (H.F.) risque de provoquer des interférences.

- Le Rayonnement haute fréquence (H.F.) peut provoquer des interférences avec les équipements de radio-navigation et de communication, les services de sécurité et les ordinateurs.
- Demander seulement à des personnes qualifiées familiarisées avec des équipements électroniques de faire fonctionner l'installation.
- L'utilisateur est tenu de faire corriger rapidement par un électricien qualifié les interférences résultant de l'installation.
- Si le FCC signale des interférences, arrêter immédiatement l'appareil.
- Effectuer régulièrement le contrôle et l'entretien de l'installation.
- Maintenir soigneusement fermés les portes et les panneaux des sources de haute fréquence, maintenir les éclateurs à une distance correcte et utiliser une terre et un blindage pour réduire les interférences éventuelles.

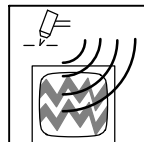

LE COUPAGE À L'ARC peut causer des interférences.

- L'énergie électromagnétique peut gêner le fonctionnement d'appareils électroniques comme des ordinateurs et des robots.
- Pour réduire la possibilité d'interférence, maintenir les câbles aussi courts que possible, les grouper, et les poser aussi bas que possible (ex. par terre).
- Veiller à couper à une distance de 100 mètres de tout équipement électronique sensible.
- S'assurer que la source de coupage est correctement branchée et mise à la terre.
- Si l'interférence persiste, l'utilisateur doit prendre des mesures supplémentaires comme écarter la machine, utiliser des câbles blindés de des filtres, ou boucler la zone de travail.

2-4. Proposition californienne 65 Avertissements

⚠ Les équipements de soudage et de coupe produisent des fumées et des gaz qui contiennent des produits chimiques dont l'État de Californie reconnaît qu'ils provoquent des malformations congénitales et, dans certains cas, des cancers. (Code de santé et de sécurité de Californie, chapitre 25249.5 et suivants)

⚠ Ce produit contient des éléments chimiques, dont le plomb, reconnus par l'État de Californie pour leur caractère cancérigène ainsi que provoquant des malformations congénitales ou autres problèmes de procréation. *Se laver les mains après toute manipulation.*

2-5. Principales normes de sécurité

Safety in Welding, Cutting, and Allied Processes, ANSI Standard Z49.1, is available as a free download from the American Welding Society at <http://www.aws.org> or purchased from Global Engineering Documents (phone: 1-877-413-5184, website: www.global.ihs.com).

Recommended Practices for Plasma Arc Cutting and Gouging, American Welding Society Standard AWS C5.2, from Global Engineering Documents (phone: 1-877-413-5184, website: www.global.ihs.com).

Safe Practices for the Preparation of Containers and Piping for Welding and Cutting, American Welding Society Standard AWS F4.1, from Global Engineering Documents (phone: 1-877-413-5184, website: www.global.ihs.com).

Safe Practices for Welding and Cutting Containers that have Held Combustibles, American Welding Society Standard AWS A6.0, from Global Engineering Documents (phone: 1-877-413-5184, website: www.global.ihs.com).

National Electrical Code, NFPA Standard 70, from National Fire Protection Association, Quincy, MA 02269 (phone: 1-800-344-3555, website: www.nfpa.org and www.sparky.org).

Safe Handling of Compressed Gases in Cylinders, CGA Pamphlet P-1, from Compressed Gas Association, 14501 George Carter Way, Suite 103, Chantilly, VA 20151 (phone: 703-788-2700, website: www.cganet.com).

Safety in Welding, Cutting, and Allied Processes, CSA Standard W117.2, from Canadian Standards Association, Standards Sales, 5060 Spectrum Way, Suite 100, Ontario, Canada L4W 5N5 (phone: 800-463-6727, website: www.csa-international.org).

Safe Practice For Occupational And Educational Eye And Face Protection, ANSI Standard Z87.1, from American National Standards Institute, 25 West 43rd Street, New York, NY 10036 (phone: 212-642-4900, website: www.ansi.org).

Standard for Fire Prevention During Welding, Cutting, and Other Hot Work, NFPA Standard 51B, from National Fire Protection Association, Quincy, MA 02269 (phone: 1-800-344-3555, website: www.nfpa.org).

OSHA, Occupational Safety and Health Standards for General Industry, Title 29, Code of Federal Regulations (CFR), Part 1910, Subpart Q, and Part 1926, Subpart J, from U.S. Government Printing Office, Superintendent of Documents, P.O. Box 371954, Pittsburgh, PA 15250-7954 (phone: 1-866-512-1800) (there are 10 OSHA Regional Offices—phone for Region 5, Chicago, is 312-353-2220, website: www.osha.gov).

Applications Manual for the Revised NIOSH Lifting Equation, The National Institute for Occupational Safety and Health (NIOSH), 1600 Clifton Rd, Atlanta, GA 30333 (phone: 1-800-232-4636, website: www.cdc.gov/NIOSH).

2-6. Informations relatives aux CEM

Le courant électrique qui traverse tout conducteur génère des champs électromagnétiques (CEM) à certains endroits. Le courant de soudage crée un CEM autour du circuit et du matériel de soudage. Les CEM peuvent créer des interférences avec certains implants médicaux comme des stimulateurs cardiaques. Des mesures de protection pour les porteurs d'implants médicaux doivent être prises: Limiter par exemple tout accès aux passants ou procéder à une évaluation des risques individuels pour les soudeurs. Tous les soudeurs doivent appliquer les procédures suivantes pour minimiser l'exposition aux CEM provenant du circuit de soudage:

1. Rassembler les câbles en les torsadant ou en les attachant avec du ruban adhésif ou avec une housse.
2. Ne pas se tenir au milieu des câbles de soudage. Disposer les câbles d'un côté et à distance de l'opérateur.
3. Ne pas courber et ne pas entourer les câbles autour de votre corps.



4. Maintenir la tête et le torse aussi loin que possible du matériel du circuit de soudage.
5. Connecter la pince sur la pièce aussi près que possible de la soudure.
6. Ne pas travailler à proximité d'une source de soudage, ni s'asseoir ou se pencher dessus.
7. Ne pas souder tout en portant la source de soudage ou le dévidoir.

En ce qui concerne les implants médicaux :



















Les porteurs d'implants doivent d'abord consulter leur médecin avant de s'approcher des opérations de soudage à l'arc, de soudage par points, de gougeage, du coupe-plasma ou de chauffage par induction. Si le médecin approuve, il est recommandé de suivre les procédures précédentes.

SECTION 3 – DEFINITIONS

3-1. Manufacturer’s Warning Label Definitions

| | |
|---|--|
|  | Warning! Watch Out! There are possible hazards as shown by the symbols. Safe1 2012-05 |
|  | When power is applied failed parts can explode or cause other parts to explode. Safe26 2012-05 |

3-2. Miscellaneous Symbols And Definitions

| | | | |
|---|--|---|---|
| A Amperes |  Plasma Arc Cutting (PAC) |  Adjust Air/Gas Pressure |  Low Air Pressure Light |
| V Volts |  Increase |  No - Do Not Do This |  Temperature |
|  Protective Earth (Ground) |  Single Phase |  Constant Current |  Voltage Input |
| I On |  Off |  Percent |  Direct Current |
| U₀ Rated No Load Voltage (Average) | U₁ Primary Voltage | U₂ Conventional Load Voltage |  Line Connection |
| I_{1max} Rated Maximum Supply Current | I₂ Rated Welding Current | X Duty Cycle |  Single Phase Static Frequency Converter-Transformer-Rectifier |
| IP Degree Of Protection |  Loose Shield Cup |  Input | Hz Hertz |
| I_{1eff} Maximum Effective Supply Current | pf power factor |  Suitable for Some Hazardous Locations | S₁ Power Rating, Product Of Voltage And Current (KVA) |

SECTION 4 – INSTALLATION

4-1. Specifications



| Power Supply | | | |
|--|--|--------------------------------------|--------------------------------------|
| Input | | | |
| Rated AC Phase and line frequency (Hz) | 1 – Phase | 60 Hz | -- |
| Rated Input Voltage (U_1) and rated Input Current (I_1) and I_1 eff at rated output. I_1 eff used to determine power cord rating | Volts AC RMS - (U_1) | Amps RMS - (I_1) | I_1 eff |
| | 120 VAC, 1-Phase (20 A) | 25.1 | 11.2 |
| | 120 VAC, 1-Phase (15 A) | 18.1 | 10.7 |
| | 240 VAC, 1-Phase | 26.7 | 18.9 |
| Power Factor/kVA/kW at Rated Output | Volts AC RMS - (U_1) | Power Factor | kVA/kW |
| | 120 VAC, 1-Phase (20 A) | 0.969 | 3.02 / 2.93 |
| | 120 VAC, 1-Phase (15 A) | 0.970 | 2.17 / 2.11 |
| | 240 VAC, 1-Phase | 0.995 | 6.41 / 6.30 |
| Peak kW at Arc Stretch | kW | 10.1 | -- |
| Output | | | |
| Rated Open Circuit Voltage (U_0) Type | 400 Volts DC/Electrode Negative | -- | -- |
| Output Characteristic | Constant Current | -- | -- |
| Rated Output Current and Voltage (I_2 , U_2) at rated Input Voltage (U_1) | Volts AC RMS - (U_1) | Amps DC - (I_2) | Volts DC - (U_2) |
| | 120 VAC, 1-Phase (20A) | 27 A | 91 V |
| | 120 VAC, 1-Phase (15 A) | 20 A | 88 V |
| | 240 VAC, 1-Phase | 40 A | 140 V |
| Output Current Range | 15 – 40 A | -- | -- |
| Duty Cycle at 104°F (40°C) and Rated Conditions (U_1 , I_1 , U_2 , I_2) based on a 10 minute period | Volts AC RMS - (U_1) | Amps DC - (I_2) | Duty Cycle % |
| | 120 VAC, 1-Phase (20A) | 27 A | 20% |
| | 120 VAC, 1-Phase (15 A) | 20 A | 35% |
| | 240 VAC, 1-Phase | 40 A | 50% |

| General | | | |
|--|--|----------------------|-----------------------|
| Operating Temperature | 5° to 104° F (-15° to 40° C) | -- | -- |
| IP Code – Degree of protection provided by enclosure | IP23CS** | -- | -- |
| | IP – International Protection | -- | -- |
| | 2 – No ingress of foreign objects \geq 12.5 mm (0.5 in.) | -- | -- |
| | 3 – No harmful ingress spraying water | -- | -- |
| | C – AC line circuits protected against ingress of tool \geq 2.5 mm dia x 100 mm long (0.1 in. x 4 in.) | -- | -- |
| | S – Fan stationary during water test | -- | -- |
| **This equipment is designed for outdoor use. It may be stored, but is not intended to be used outside during precipitation unless sheltered. | | | |
| Toppling or tilting | Up to 15° incline | -- | -- |
| Machine Weight | 21 lb (9.5 kg) including 12 ft (3.7 m) torch 23 lb (10.4 kg) including 20 ft (6.1 m) torch | -- | -- |
| Torch – The XT40 torch is intended for handheld use only. The torch conforms to IEC 60974-7 when used with the Spectrum 625 X-TREME. Do not use this torch in combination with any other machines. | | | |
| Gas Type | Air or Nitrogen | -- | -- |
| Gas Quality | Clean, moisture-free, oil-free | -- | -- |
| Gas Inlet Flow and Pressure | 6.0 SCFM (170 L/min) | 90 PSI (621 kPa) Min | 120 PSI (827 kPa) Max |
| Gas Filtering | Particulates to 5 microns | -- | -- |
| Mild Steel capacities (see Section 5-2 for cutting speeds vs material type and thickness) | | | |
| Cooling Method | Air | -- | -- |
| Duty Cycle of Torch | 100% at 40 Amps | -- | -- |
| Rating of Electrical Controls (Trigger) | 30 VDC at .1 Amps | -- | -- |
| Rating of Electrical Controls (Cup) | 30 VDC at 1 Amp | -- | -- |
| Approved Systems | Spectrum 625 X-TREME w/XT40 torch | | |
| Trigger Protection | Safety trigger guard | | |
| Safety Devices | Safety interlock devices shut down power source | | |
| Rated Capacity (edge start) | 5/8 in. at 13 ipm (330 mm/min)* | -- | -- |
| Sever Cut Capacity (edge start) | 7/8 in. at 4 ipm (102 mm/min)* | -- | -- |
| Pierce Capacity | 5/16 in. | -- | -- |
| *Travel speeds are approximately 80% of maximum. | | | |
| Requirements for the torch connection | | | |
| <ul style="list-style-type: none"> • Use only compressed air which is free from dirt, oil, and water. • Ensure that the connections are properly assigned and tightened. • For torch replacement, see Miller torch manual Part No. OM-254449 • Ensure correct air pressure (flow pressure) and airflow (volume) are set. Insufficient airflow can lead to the torch overheating. | | | |

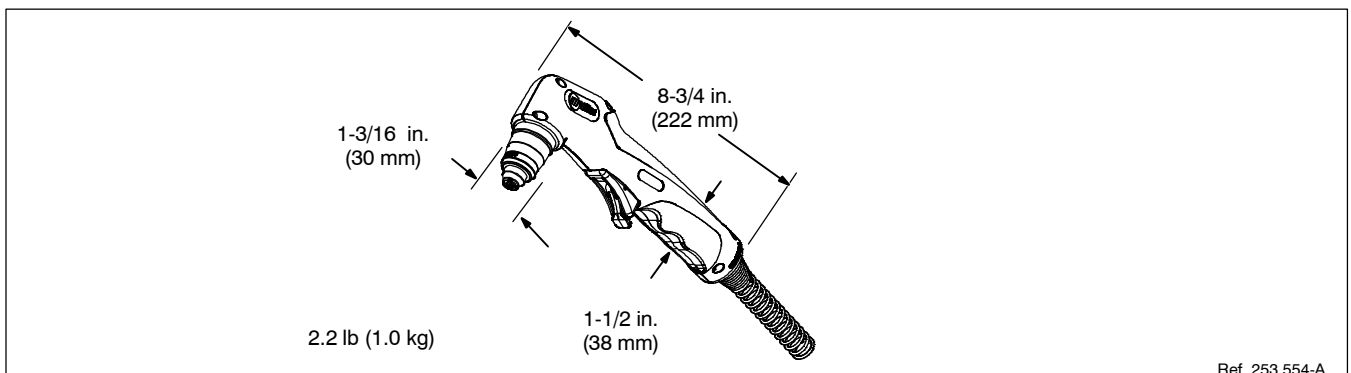
4-2. Torch Dimensions And Weight



4-3. Duty Cycle And Overheating



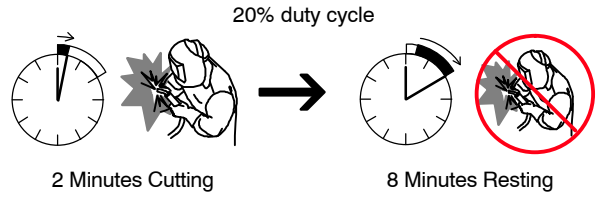

20% duty cycle

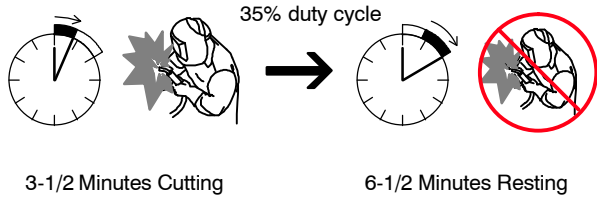

2 Minutes Cutting 8 Minutes Resting

35% duty cycle



3-1/2 Minutes Cutting 6-1/2 Minutes Resting

50% duty cycle

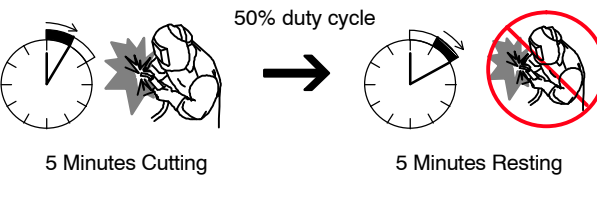

5 Minutes Cutting 5 Minutes Resting

Duty Cycle is percentage of 10 minutes that unit can cut at rated load without overheating.

If unit overheats, thermostat(s) opens, output stops, Temperature trouble light goes On, and cooling fan runs. Wait fifteen minutes for unit to cool or temperature light to go off. Reduce amperage or duty cycle before cutting or gouging.

NOTICE – Exceeding duty cycle can damage unit and void warranty.

Overheating

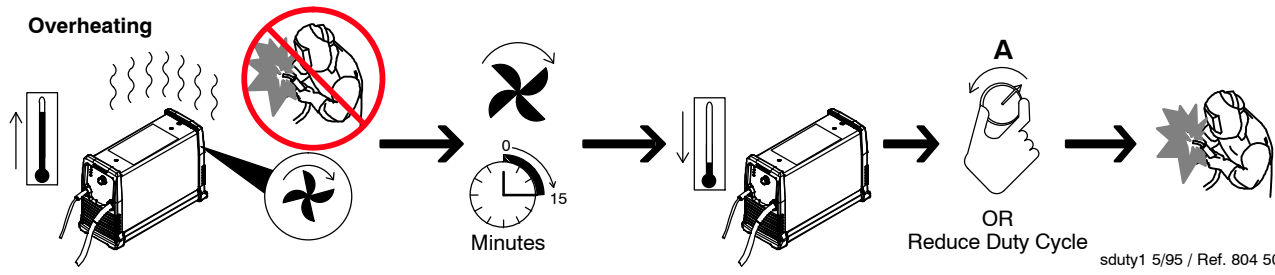

Minutes 15

OR
Reduce Duty Cycle

sduty1 5/95 / Ref. 804 503-A

4-4. Power Source Dimensions And Weight

Dimensions And Weight

21 lb (9.5 kg)
including 12 ft (3.7 m) torch

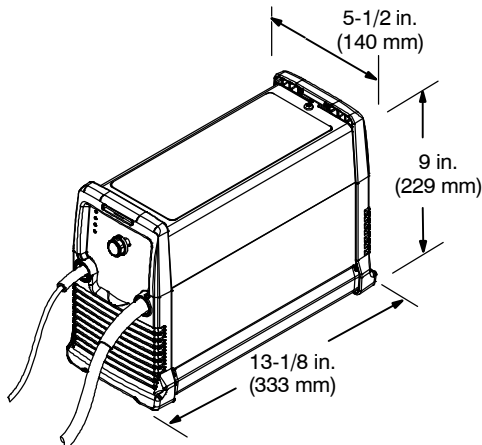

⚠ Do not move or operate unit where it could tip.



loc_2 3/96 - Ref. 805 325-A

4-5. Serial Number And Rating Label Location

The serial number and rating information for this product is located on the bottom. Use rating label to determine input power requirements and/or rated output. For future reference, write serial number in space provided on back cover of this manual.

4-6. Selecting A Location



⚠ Do not move or operate unit where it could tip.



1 Line Disconnect Device

Locate unit near correct input power supply.

Locate unit at least 18 in. (460 mm) away from a wall or other obstruction to allow adequate clearance for cooling air flow.

⚠ Special installation may be required where gasoline or volatile liquids are present – see NEC Article 511 or CEC Section 20.

Location

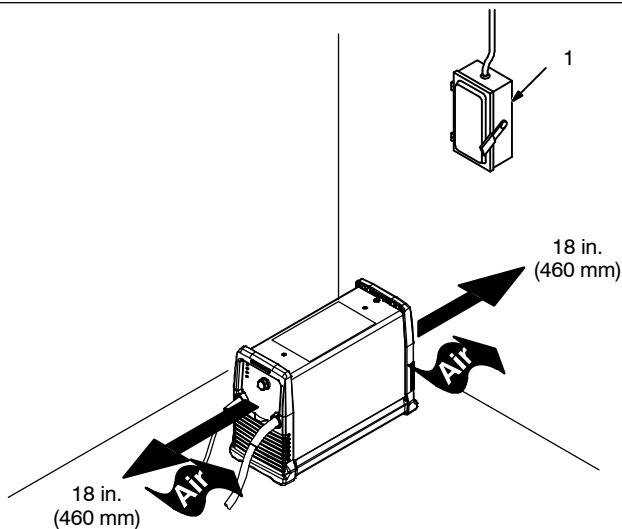

loc_2 3/96 - Ref. ST-151 556 / Ref. 804 503-A

4-7. Connecting Gas/Air Supply

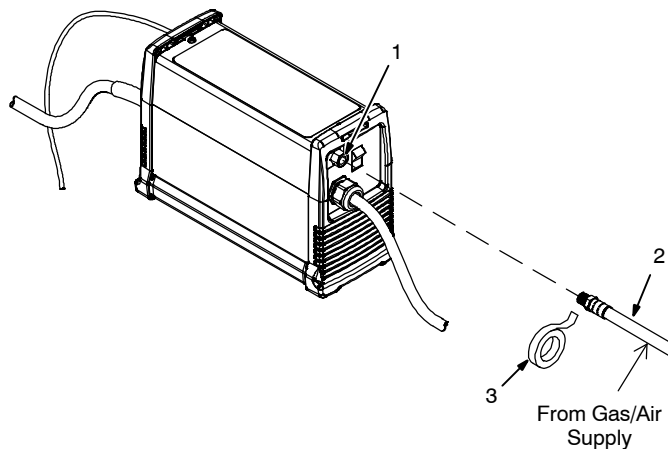

☞ Use only clean, dry air with 90 to 120 psi (621 to 827 kPa) pressure.

- 1 Gas/Air Inlet Opening
- 2 Hose
- 3 Teflon Tape

Obtain hose with 1/4 NPT right-hand thread fitting. Wrap threads with teflon tape (optional) or apply pipe sealant, and install fitting in opening. Route hose to gas/air supply.

Tools Needed:



9/16 in.

Ref. 805 326-A

4-8. Connecting Work Clamp

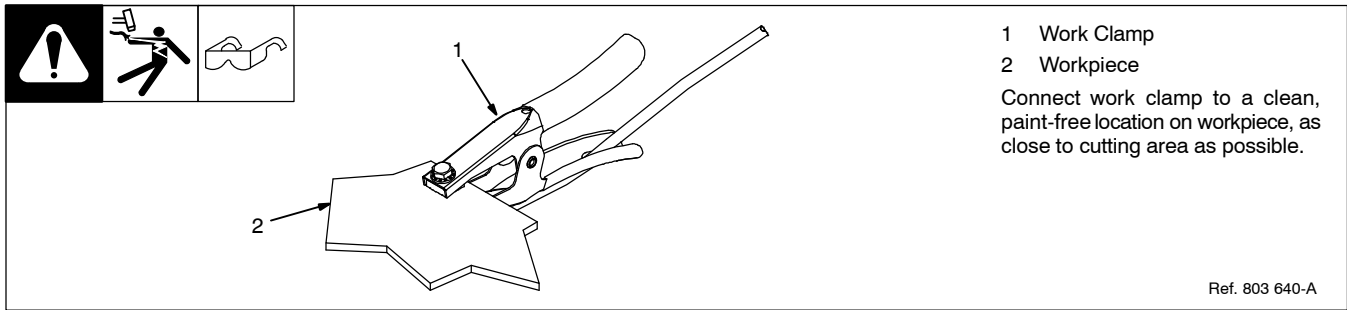

4-9. Electrical Service Guide

Elec Serv 2011-08

⚠ Failure to follow these electrical service guide recommendations could create an electric shock or fire hazard. These recommendations are for a dedicated circuit sized for the rated output and duty cycle of the welding power source. In dedicated circuit installations, the National Electrical Code (NEC) allows the receptacle or conductor rating to be less than the rating of the circuit protection device. All components of the circuit must be physically compatible. See NEC articles 210.21, 630.11, and 630.12.

NOTICE – Actual input voltage should not be 10% less than minimum and/or 10% more than maximum input voltages listed in table. If actual input voltage is outside this range, output may not be available.

| Input Voltage (V) | 60 Hz Single Phase | |
|--|---|----------|
| | 120 | 240 |
| Input Amperes (A) At Rated Output | | 27 |
| Max Recommended Standard Fuse Rating In Amperes ¹ | A 15 or 20 ampere individual branch circuit protected by time-delay fuses or circuit breaker is required. See Section 4-1 | 35 |
| Time-Delay Fuses ² | | 45 |
| Normal Operating Fuses ³ | | 10 |
| Min Input Conductor Size In AWG ⁴ | | 130 (40) |
| Max Recommended Input Conductor Length In Feet (Meters) | | 10 |
| Min Grounding Conductor Size In AWG ⁴ | | |

Reference: 2011 National Electrical Code (NEC) (including article 630)

- 1 If a circuit breaker is used in place of a fuse, choose a circuit breaker with time-current curves comparable to the recommended fuse.
- 2 "Time-Delay" fuses are UL class "RK5" . See UL 248.
- 3 "Normal Operating" (general purpose - no intentional delay) fuses are UL class "K5" (up to and including 60 amps), and UL class "H" (65 amps and above).
- 4 Conductor data in this section specifies conductor size (excluding flexible cord or cable) between the panelboard and the equipment per NEC Table 310.15(B)(16). If a flexible cord or cable is used, minimum conductor size may increase. See NEC Table 400.5(A) for flexible cord and cable requirements.

4-10. Extension Cord Data

☞ When calculating max. cord length, remember to include conductor length from line disconnect device to input power receptacle.

| Single Phase AC Input Voltage | Conductor Size – AWG (mm ²)* | | | | |
|---|--|----------|----------|----------|----------|
| | 6 (13.3) | 8 (8.4) | 10 (5.3) | 12 (3.3) | 14 (2.1) |
| Maximum Allowable Cord Length in ft (m) | | | | | |
| 120 | 182 (55) | 114 (35) | 72 (22) | 45 (14) | 29 (9) |
| 240 | 340 (104) | 210 (64) | 130 (40) | -- | -- |

*Conductor size is based on maximum 3% voltage drop

4-11. Multi-Voltage Plug Adapter (MVP) Connection



Selecting Plug Adapter

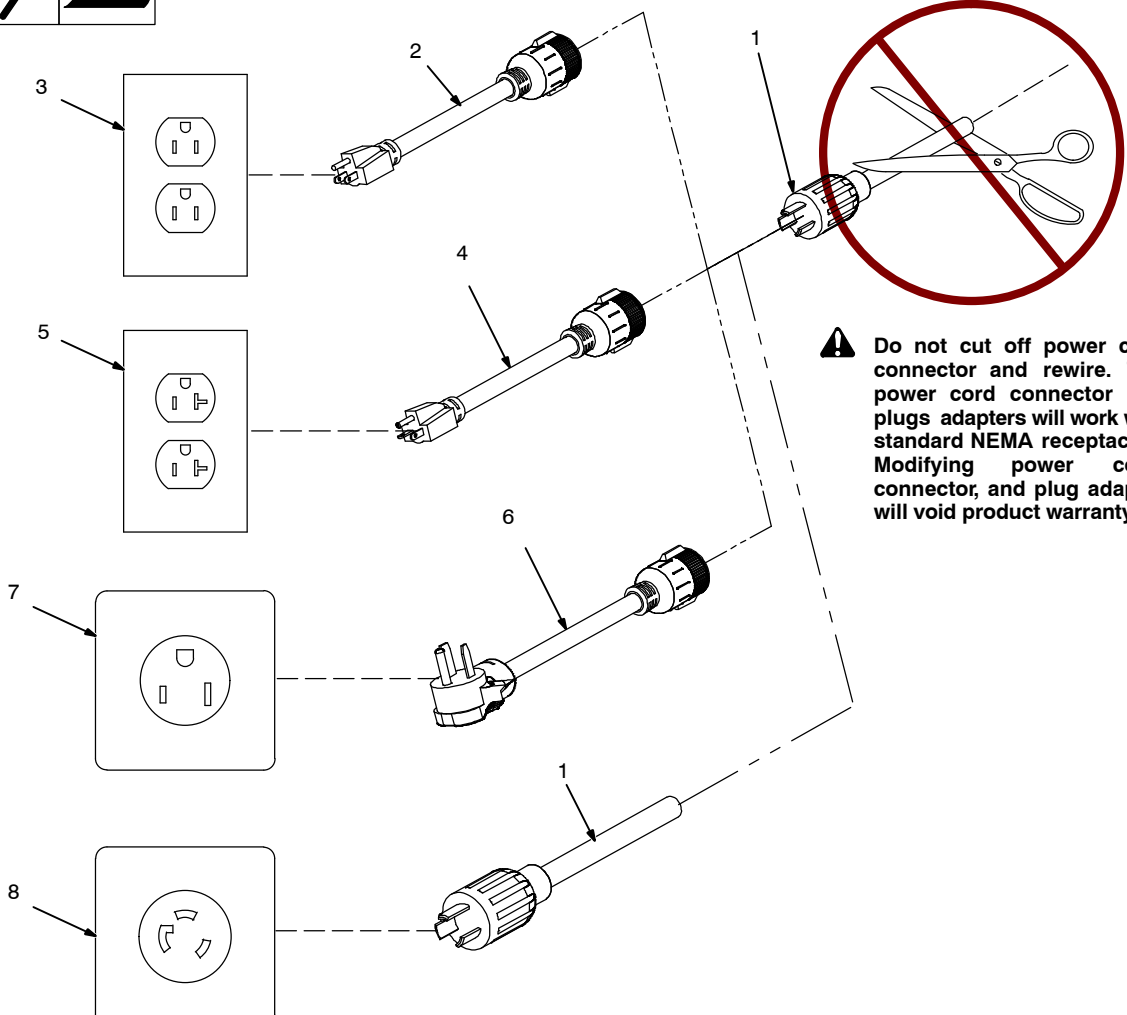

⚠ Do not cut off power cord connector and rewire. The power cord connector and plugs adapters will work with standard NEMA receptacles. Modifying power cord, connector, and plug adapter will void product warranty.

Connecting Plug Adapter To Power Cord

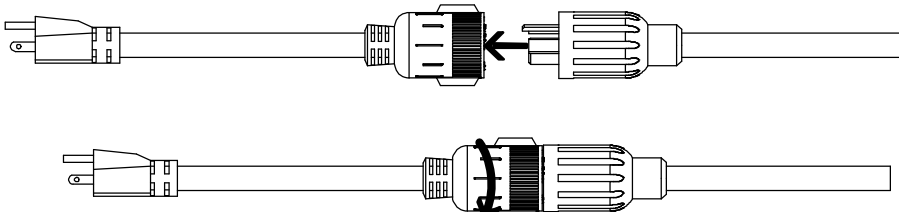

Selecting Plug Adapter

1 Power Cord Connector From Welding Power Source – NEMA Type L6–30P

Select plug adapter for power supply receptacle available at site. Not all plug adapters shown are provided as standard with unit.

2 Plug Adapter – NEMA Type 5–15P

3 Receptacle – NEMA Type 5–15R (Customer Supplied)

4 Plug Adapter – NEMA Type 5–20P (Optional)

5 Receptacle – NEMA Type 5–20R (Customer Supplied)

6 Plug Adapter – NEMA Type 6–50P

7 Receptacle – NEMA Type 6–50R (Customer Supplied)

8 Receptacle – NEMA Type L6–30R (Customer Supplied)

⚠ Follow electrical service guide for 240 VAC in Section 4-9. Do not use plug rating to size branch circuit protection.

Connecting Plug Adapter To Power Cord

Align plug adapter and power cord contacts. Push together.

Turn plug adapter clockwise until completely tight.

Connect plug to receptacle.

4-12. Connecting 120 Volt Input Power



⚠ Installation must meet all National and Local Codes – have only qualified persons make this installation.

⚠ Special installation may be required where gasoline or volatile liquids are present – see NEC Article 511 or CEC Section 20.

See rating label on unit and check input voltage available at site.

☞ The Auto-Line circuitry in this unit automatically links the power source to the primary voltage being applied, either 120 or 240 VAC.

For 120 volts AC input power, a 15 or 20 ampere individual branch circuit protected by time-delay fuses or circuit breaker is required.

1 Multi-Voltage Plug Adapter And Power Cord Connector (NEMA Type 5-15P Plug Shown)

For multi-voltage plug adapter connections, see Section 4-11.

2 Receptacle – NEMA Type 5-15R (Customer Supplied)

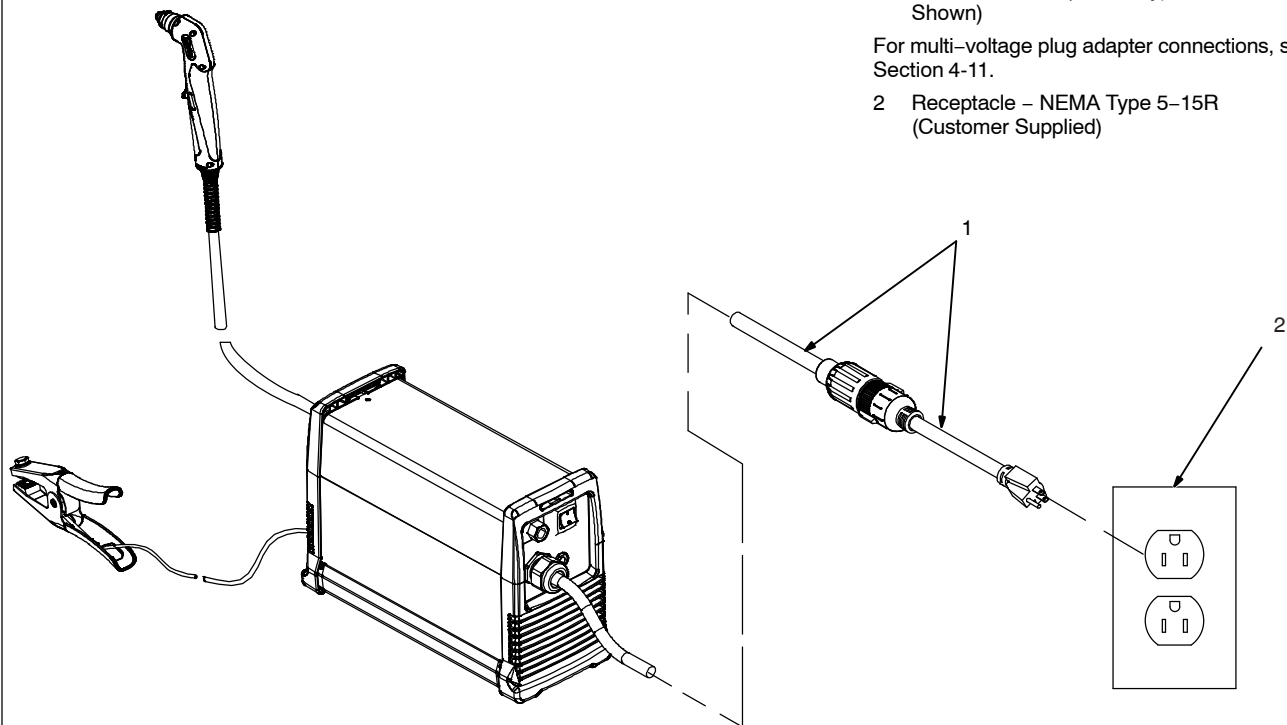

Input6 2011-03 Ref. 253 558-A / Ref. 254 665-A

SECTION 5 – OPERATION

5-1. Controls

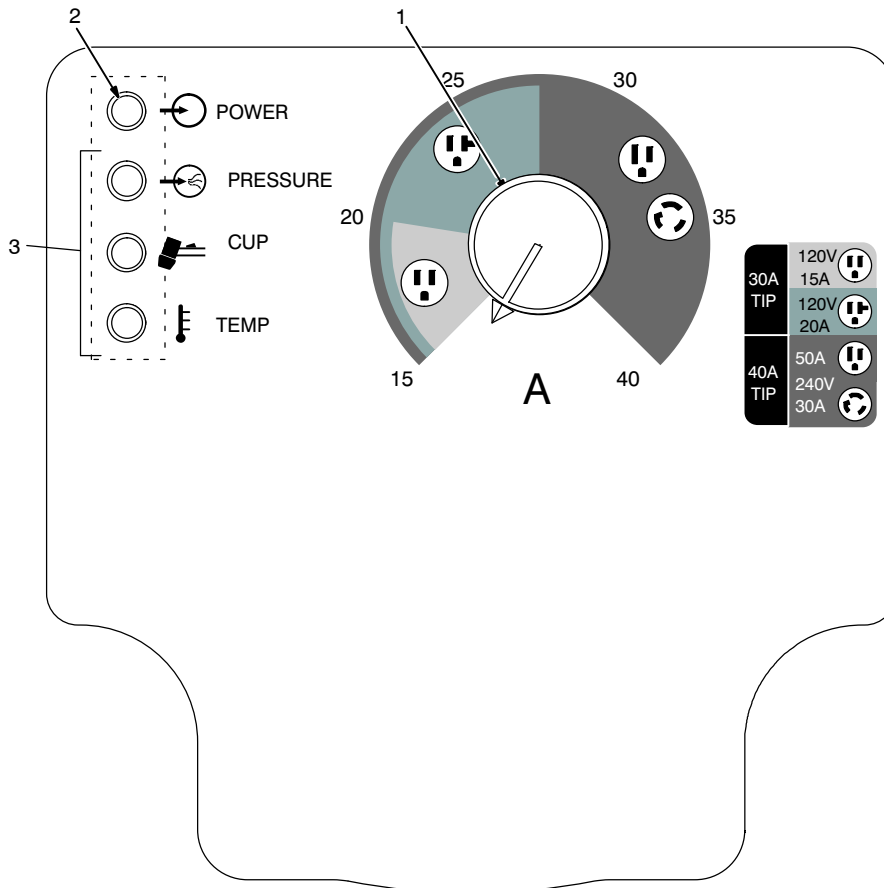
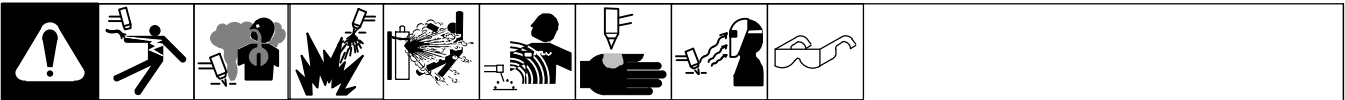

253 015-A

1 Output Control
Use control to set cutting output.

2 Power Light

3 Trouble Lights (See Section 6-4)

5-2. Mild Steel Recommended Cut Speed

Recommended Cut Speeds At 40 Amperes Output

| Mild Steel | Thickness | | Approximate Travel Speed* | |
|------------|-----------|-----|---------------------------|--------|
| | Inches | mm | IPM | mm/min |
| | 1/8 | 3.2 | 156 | 3962 |
| 1/4 | 6.4 | 64 | 1626 | |
| 3/8 | 9.5 | 36 | 914 | |
| 1/2 | 12.7 | 22 | 559 | |
| 5/8 | 15.9 | 13 | 330 | |

*Recommended Cut Speed is approximately 80% of maximum.

☞ Aluminum and stainless steel cut speeds at these thicknesses may be reduced as much as 30%.









Recommended Cut Speeds At 27 Amperes Output

| Mild Steel | Thickness | | Recommended Cut Speeds* | |
|------------|-----------|-----|-------------------------|--------|
| | Inches | mm | IPM | mm/min |
| | 1/8 | 3.2 | 88 | 2,235 |
| 1/4 | 6.4 | 28 | 711 | |
| 3/8 | 9.5 | 15 | 381 | |
| 1/2 | 12.7 | 8 | 203 | |
| 5/8 | 15.9 | 5 | 127 | |

*Recommended Cut Speed is approximately 80% of maximum.

☞ Aluminum and Stainless Steel cut speeds at these thicknesses may be reduced as much as 20%.

5-3. Trigger Safety Lock

1 Trigger

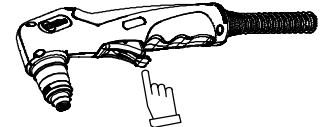

Trigger Locked

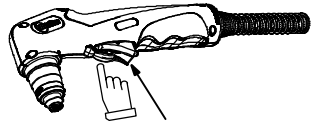

1
Trigger Unlocked

Ref. 253554-A

5-4. Plasma Cutting System Practices

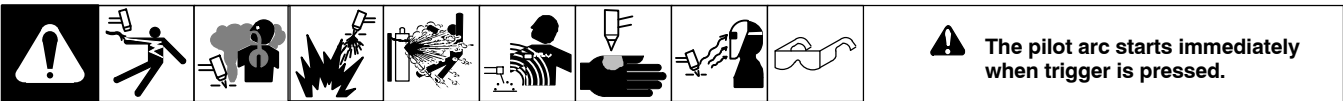

⚠ The pilot arc starts immediately when trigger is pressed.

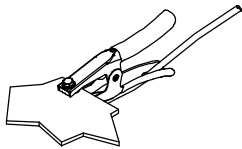

Always connect work clamp to a clean, paint-free location on workpiece, as close to cutting area as possible.

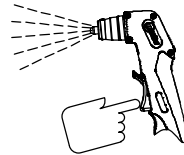

DO NOT start pilot arc without cutting or gouging as this shortens the service life of the nozzle and electrode.

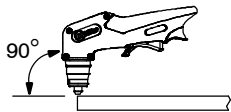

Maintain approximately a 90° angle to the workpiece surface for proper cutting results.

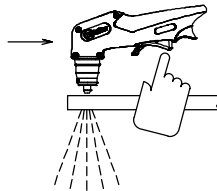

Sparks should pass through the workpiece and out the bottom when cutting.

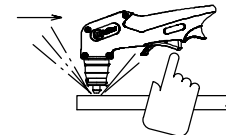

If sparks flare back from surface, this usually is an indication that either travel speed is too fast or amperage is set too low.

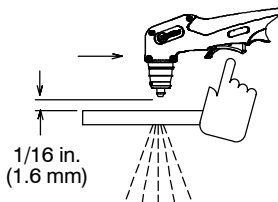

When doing **extended (non-shielded)** cutting, maintain approximately 1/16 in. standoff between electrode and surface.

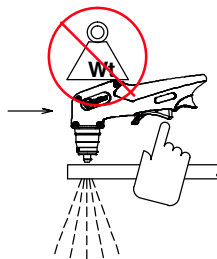

DO NOT put pressure on shield when **drag cutting**; instead, slide shield along the surface for proper cutting results.

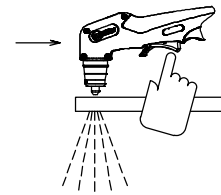

Pulling rather than pushing the torch makes cutting easier. Use a proper guide or template for accurate cutting operations.

Ref. 254 087-A

5-5. Sequence Of Cutting Operation

| | | | | | | | | |
|--|--|--|--|--|--|--|--|--|
| | | | | | | | | |
|--|--|--|--|--|--|--|--|--|

| | | | | |
|--|---|--|---|--|
| <p>Connect work clamp to a clean, paint-free location on workpiece, as close to cutting area as possible.</p> | → | <p>For standard (shielded) cutting, place drag shield on edge of metal. For extended (non-shielded) cutting, use 1/8 in. (3.2 mm) standoff distance (dragging tip will reduce tip life).</p> | | |
| <p>⚠ The pilot arc starts immediately when trigger is pressed.</p> <p>Raise trigger lock and press trigger. Pilot arc starts.</p> | → | <p>After cutting arc starts, slowly start moving torch across metal.</p> | | |
| <p>Adjust torch speed so sparks go thru metal and out bottom of cut.</p> | → | <p>Pause briefly at end of cut before releasing trigger.</p> | → | <p>Postflow continues for approx. 20 seconds after releasing trigger; cutting arc can be instantly restarted during postflow by raising trigger lock and pressing trigger.</p> |

Ref. 254 087-A

5-6. Sequence Of Gouging Operation

| | | | | | | | | | |
|--|--|--|--|--|--|--|--|--|--|
| | | | | | | | | | |
|--|--|--|--|--|--|--|--|--|--|

Connect work clamp to a clean, paint-free location on workpiece, as close to cutting area as possible.

Trigger pilot arc once before starting to gouge.

⚠ The pilot arc starts immediately when trigger is pressed.

Hold torch at approximately 45° angle to workpiece.

Raise trigger lock and press trigger. Pilot arc starts. Move tip to within approximately 3/16 in. (4.8 mm). Start gouging across workpiece surface. Maintain approximately a 45° angle to surface.

Release trigger. Postflow continues for approx. 20 seconds after releasing trigger; arc can be instantly restarted during postflow by raising trigger lock and pressing trigger.

Ref. 254 087-A

5-7. Sequence Of Piercing Operation

| | | | | | | | | | |
|---|--|--|--|--|--|--|--|--|--|
| | | | | | | | | | |
| <p>The pilot arc starts immediately when trigger is pressed.</p> | | | | | | | | | |

| | | | | |
|--|---|--|---|---|
| | → | | | |
| <p>Connect work clamp to a clean, paint-free location on workpiece, as close to cutting area as possible.</p> | | <p>Hold torch at approximately 45° to the workpiece. Raise trigger lock and press trigger. Pilot arc starts.</p> | | |
| | → | | → | |
| <p>Rotate torch to upright position approximately 90° to surface. When arc has pierced through workpiece, start cutting.</p> | | <p>Maintain approximately 90° torch position to surface, and continue cutting.</p> | | <p>Release trigger. Postflow continues for approx. 20 seconds after releasing trigger; arc can be instantly restarted during postflow by raising trigger lock and pressing trigger.</p> |

Ref. 254 087-A

SECTION 6 – MAINTENANCE & TROUBLESHOOTING

6-1. Routine Maintenance

| | | | | | | | | | | |
|--|--|--|--|--|--|--|--|---|--|--|
| | | | | | | | | Disconnect power before maintaining. | | <i>Maintain more often during severe conditions.</i> |
|--|--|--|--|--|--|--|--|---|--|--|

| | ✓ = Check * To be done by Factory Authorized Service Agent | ◇ = Change ● = Clean | ☆ = Replace | Reference | |
|----------------|---|--|---------------------|----------------------|----------------|
| Each Use | ✓ Gas/Air Pressure | ✓ Torch Tip, Electrode, And Shield Cup | | Section 4-1, 6-6 | |
| Every Week | ✓ Shield Cup Shutdown System | | | Section 6-5 | |
| Every 3 Months | ☆ Damaged Or Unreadable Labels | ● Air Filter/Regulator | ☆ Cracked Parts | ✓ ☆ Gas/Air Hose | Section 6-3, 8 |
| Every 6 Months | ✓ ☆ Torch Body, Cable | | | | |
| Every 6 Months | ● Inside Unit | | | | |

6-2. Wrapper Removal



⚠ Turn off power, and disconnect input power plug from receptacle before working on unit. Check to see that all diagnostic LEDs have stopped flashing before removing wrapper from unit.

- 1 Wrapper
 - 2 Torx Screws (Fine Thread)
- Remove Torx screws and slide wrapper off.

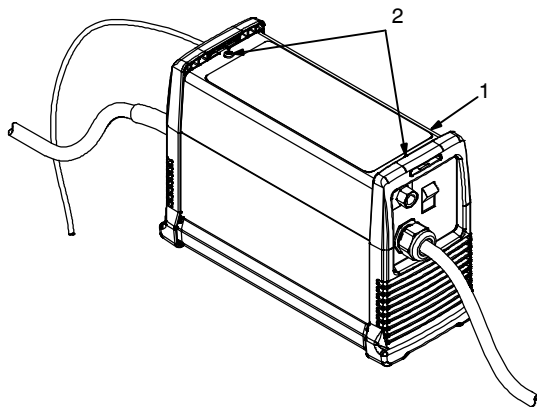

Tools Needed:



Torx 25

Ref. 805 326-A

6-3. Checking Or Replacing Filter Element

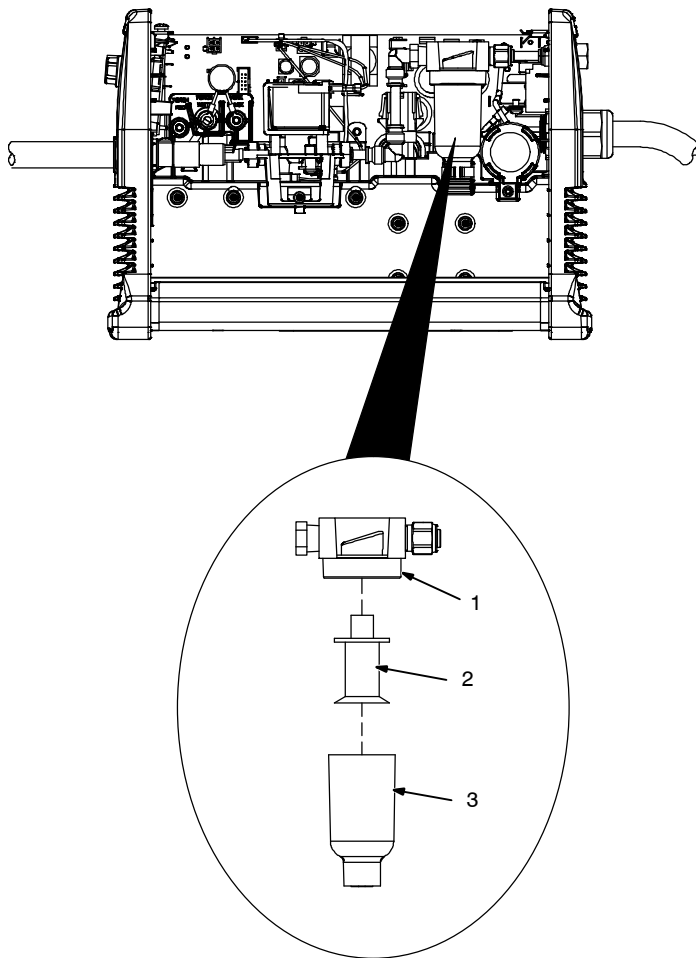

⚠ Turn power Off, and disconnect input power plug from receptacle. Check to see that all diagnostic LEDs have stopped flashing before removing wrapper from unit.

Remove wrapper from unit (see Section 6-2).

- 1 Filter Base
- 2 Filter
- 3 Filter Cup

Unscrew filter cup from base.

Remove cup.

Unscrew filter element from base.

Check filter element for dirt and moisture, and replace if necessary.

Be sure that all parts are clean and dry.

Reinstall filter element, and secure filter cup.

Reinstall wrapper.





Tools Needed:



Torx 25

6-4. Status/Trouble Lights

☞ Difficulty establishing a pilot arc may indicate consumables need to be cleaned or replaced.

| Light | Condition | Status/Possible Cause |
|--|--|---|
|  POWER  PRESSURE  CUP  TEMP | | |
| Power | On | Input power is okay. |
| Pressure/Cup/Temp | Off | When Power light is on, system is normal if these lights are off. |
| Power | Flashing rate is steady for 15 seconds or until torch trigger is pressed again, whichever comes first. | Input power below 156 volts AC, but has returned to normal. |
| Power | Repetitive flashing rate of two quick cycles, then a one second pause. | Input power is below 156 volts AC. |
| Pressure | On | No or low [below 40 psi (276 kPa)] input pressure. |
| Pressure | Flashing rate is steady for 15 seconds or until torch trigger is pressed again, whichever comes first. | Regulated pressure in the unit is low. Check torch for leaks. Check input pressure to unit is between 90 to 120 psi (621 to 827 kPa). |
| Pressure | Repetitive flashing rate of two quick cycles, then a one second pause for a 15 second period. | Regulated pressure in the unit is high. Check input pressure to unit is between 90 to 120 psi (621 to 827 kPa) or pressure transducer has failed. |
| Cup | On | Torch cup is loose or off. Once cup is tightened, unit power must be cycled off and back on again. |
| Cup | Flashing rate is steady for 15 seconds or until torch trigger is pressed again, whichever comes first. | No arc was established. Check consumables or torch. |
| Cup | Repetitive flashing rate of two quick cycles, then a one second pause for a 15 second period or until torch trigger is pressed again, whichever comes first. | No pilot arc established possibly due to a loss of current. Check consumables. |
| Cup | Repetitive flashing rate of three quick cycles, then a one second pause for a 15 second period or until torch trigger is pressed again, whichever comes first. | Consumables in torch failed to separate during pilot arc possibly due to being stuck. Check consumables. |
| Temperature | On | Power source overheated (see Section 4-3). Stop cutting and allow unit to cool down. |
| Temperature | On (indefinitely) | Power source temperature sensors may have failed or ambient temperature is below -22° F (-30° C). |
| Temperature | Flashing rate is steady (indefinitely). | Power source temperature sensor provided inaccurate readings, but returned to normal. Unit power must be cycled off and back on again. |

For system troubleshooting see Section 6-7 and Section 6-8.

6-6. Checking/Replacing Retaining Cup, Tip, And Electrode



⚠ Overtightening will strip threads. Do not overtighten retaining cup during assembly. Do not cross-thread parts causing stripping. Use care during torch assembly and parts replacement.

⚠ Inspect shield cup, tip, and electrode for wear before cutting or whenever cutting speed has been significantly reduced. Do not operate torch without a tip or electrode in place. Be sure to use genuine replacement parts.

☞ A good practice is to replace both the tip and electrode at the same time.

⚠ Turn Off power source before checking torch parts.

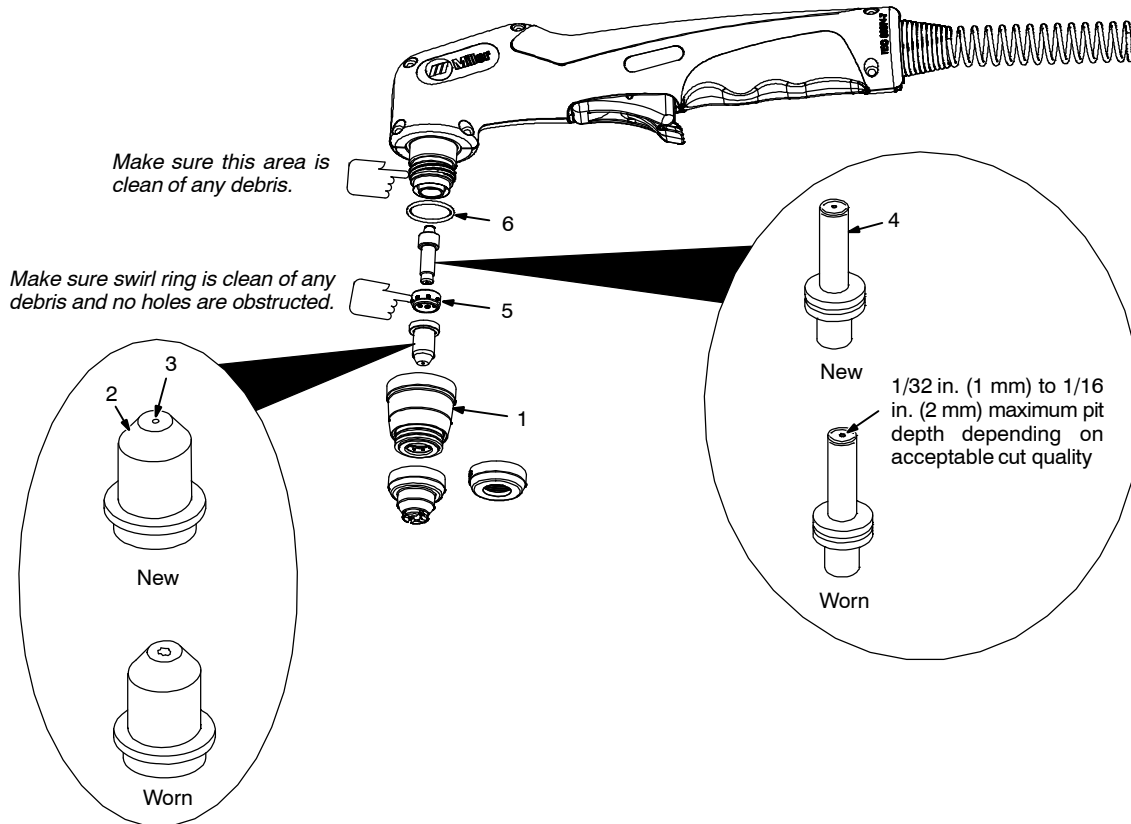

Ref. 253554-A

Turn Off power source.

1 Shield Cup

Remove shield cup. Check cup for cracks, and replace if necessary.

2 Tip

3 Opening

Remove tip. Check tip, and replace if opening is deformed or 50% oversize. If inside of tip is not clean and bright, clean with steel wool. Be sure to remove any pieces of steel wool afterwards.

4 Electrode

Check electrode. If center has a pit more than a 1/16 in. (2 mm) deep, remove and replace electrode.

5 Swirl Ring

Remove swirl ring. Check ring, and replace if side holes are plugged.

6 O-Ring

Check O-ring for cracks or worn spots, and replace if necessary.

Carefully reassemble parts in reverse order.

6-7. Troubleshooting Power Source

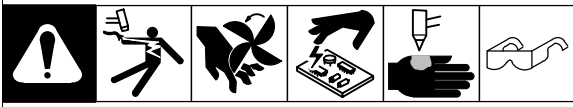
|  | | | | | |
|---|--|--|---|--|--|
| Trouble | | | Remedy | | |
| No pilot arc; difficulty in establishing an arc. | | | Clean or replace worn consumables as necessary (see torch Owner's Manual). | | |
| | | | Check for damaged torch or torch cable (see torch Owner's Manual). | | |
| No cutting output; Power light off; status lights off; fan motor FM does not run. | | | Place Power switch in On position. | | |
| | | | Place line disconnect device in On position (see Section 4-13). | | |
| | | | Check line fuse(s) and replace if needed or reset circuit breakers (see Section 4-13). | | |
| Pilot arc working; no cutting output; Power light on; status lights off; fan motor running. | | | Be sure work clamp is connected. | | |
| | | | Clean or replace worn consumables as necessary (see torch Owner's Manual). | | |
| No gas/air flow; Power light on; status lights off; fan motor running. | | | Have Factory Authorized Service Agent check for proper torch connections. Check operation of gas valve AS1, and check gas/air system for leaks. Check filter element (see Section 6-3). | | |
| Pressure status light On. | | | Check for sufficient gas/air supply pressure (see Section 4-7). | | |
| | | | Check for dirty air filter and replace, if necessary (see manufacturer's instructions). | | |
| | | | Check air lines for leaks. | | |
| | | | Have Factory Authorized Service Agent check pressure switch and control board. | | |
| Cup status light On. | | | Check torch shield cup (see Section 6-5). Reset power switch. | | |
| | | | Have Factory Authorized Service Agent check torch. | | |
| Temperature status light On. | | | Unit overheating. Allow fan to run; the Trouble light goes out when the unit has cooled. | | |
| | | | Have Factory Authorized Service Agent check control board. | | |
| Status lights not working. | | | Have Factory Authorized Service Agent check unit. | | |
| Power light flashing, status lights off. | | | Reset power switch. Have qualified technician check input line power. | | |
| Pressure status light flashes. | | | Unit lost pressure (momentarily) while cutting. Check air line for leaks. | | |
| Cup status light flashes. | | | Unit lost output while attempting to cut or pilot. Check consumables and torch for wear. | | |
| Short tip life. | | | Check and clean drag shield of any slag, particles, and debris. | | |
| | | | Check input air pressure. | | |

SECTION 7 – ELECTRICAL DIAGRAM

| | |
|---|--|
|  | WARNING |
| | <ul style="list-style-type: none"> Do not touch live electrical parts. Disconnect input power or stop engine before servicing. Do not operate with covers removed. Have only qualified persons install, use, or service this unit. |
| ELECTRIC SHOCK HAZARD | |

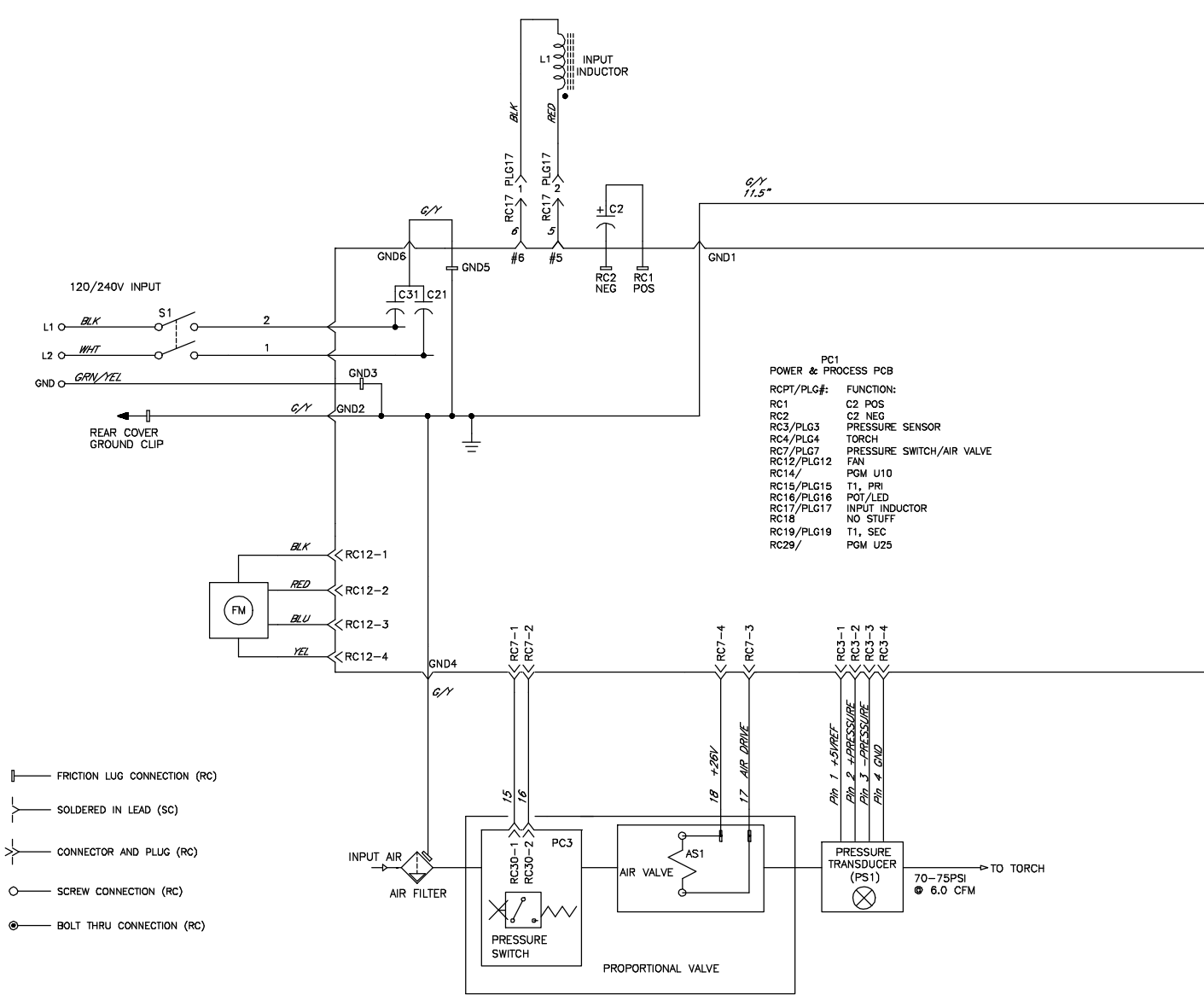
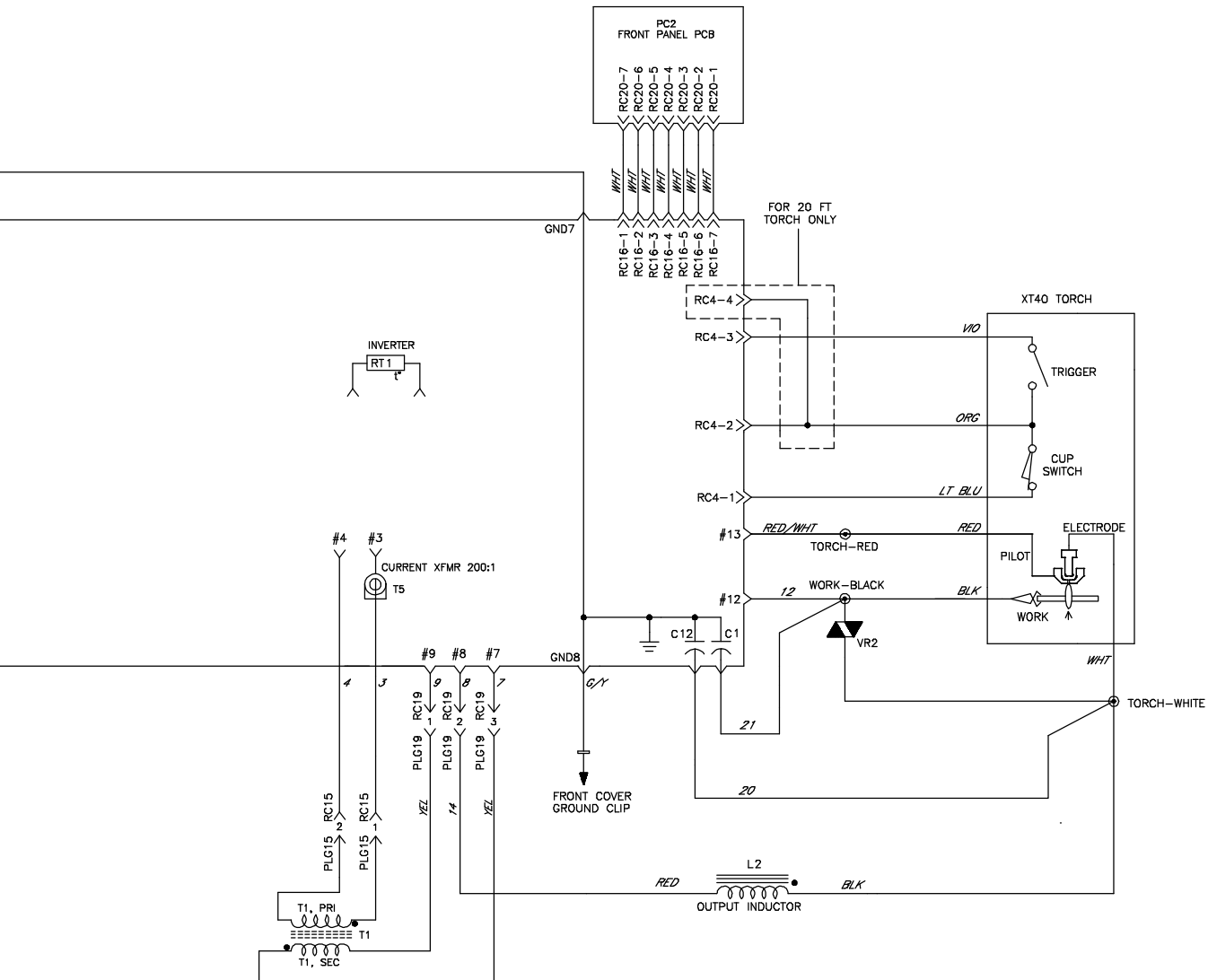

Figure 7-1. Circuit Diagram



SECTION 8 – PARTS LIST

8-1. Recommended Spare Parts

| Item No. | Dia. Mkgs. | Part No. | Description | Quantity |
|--------------------------------|------------|----------|---|----------|
| Recommended Spare Parts | | | | |
| | | 253008 | .. Cord Set, 250V 6-30P 10ga 3/C 12 ft st jkt Locking | 1 |
| | | 254330 | .. Adapter, 5-15PXL630R | 1 |
| | | 254328 | .. Adapter, 6-50PXL630R | 1 |
| | | 238486 | .. Element, Filter Air | 1 |
| | | 249951 | .. XT40, 12 ft Hand Held Torch (Replacement) | 1 |
| | | 249952 | .. XT40, 20 ft Hand Held Torch (Replacement) | 1 |
| | | 225916 | .. Cable, Work 12 FT 8 GA W/Clamp Strain RLF & TERM | 1 |
| | | 254655 | .. Label, XT40 Consumables | 1 |
| | | 254331 | .. Adapter, 5-20PXL630R | 1 |

☞ A complete Parts List is available on-line at www.MillerWelds.com

To maintain the factory original performance of your equipment, use only Manufacturer's Suggested Replacement Parts. Model and serial number required when ordering parts from your local distributor.

☞ For extended tip use, set Amperage control to 40.

XT40 CONSUMABLES

NOTICE

FAILURE TO REPLACE WORN TIP OR ELECTRODE WILL DAMAGE TORCH AND VOID WARRANTY.

- Turn off power before checking torch parts.
- Check before each use and hourly during operation.

PLUG CONFIGURATIONS TO USE WITH THE BRANCH CIRCUITS SHOWN.

15A 120V
254330

20A 120V
254331

30A 240V
MACHINE
CORD

50A 240V
254328

254655-A

Figure 8-1. Consumable Parts For XT40

☞ A complete Parts List is available on-line at www.MillerWelds.com

To maintain the factory original performance of your equipment, use only Manufacturer's Suggested Replacement Parts. Model and serial number required when ordering parts from your local distributor.

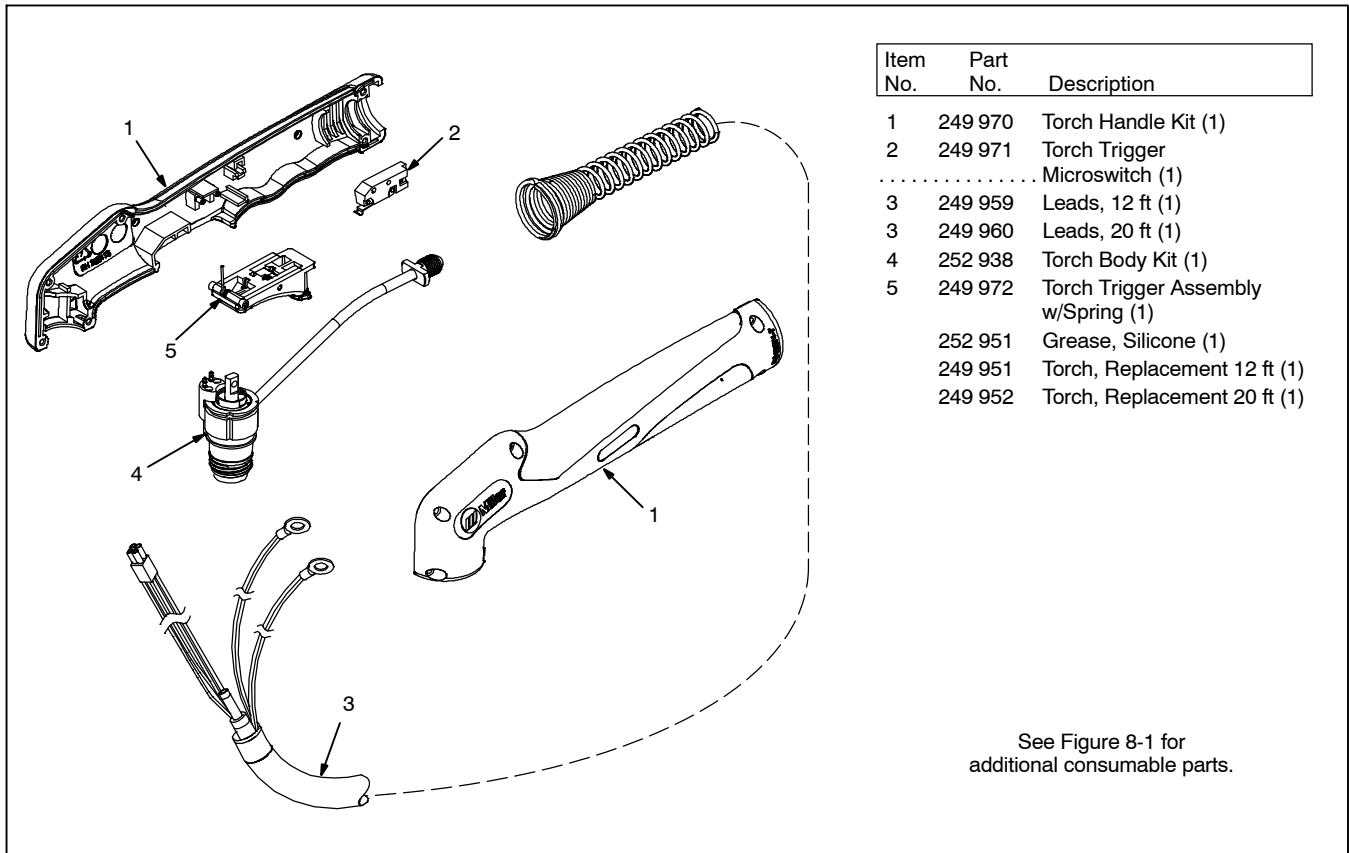

Figure 8-2. Torch, XT40

 A complete Parts List is available on-line at www.MillerWelds.com

To maintain the factory original performance of your equipment, use only Manufacturer's Suggested Replacement Parts. Model and serial number required when ordering parts from your local distributor.

TRUE BLUE[®]

WARRANTY

Effective January 1, 2012

(Equipment with a serial number preface of MC or newer)

This limited warranty supersedes all previous Miller warranties and is exclusive with no other guarantees or warranties expressed or implied.

Warranty Questions?

Call
1-800-4-A-MILLER
for your local
Miller distributor.

Your distributor also gives
you ...

Service

You always get the fast,
reliable response you
need. Most replacement
parts can be in your
hands in 24 hours.

Support

Need fast answers to the
tough welding questions?
Contact your distributor.
The expertise of the
distributor and Miller is
there to help you, every
step of the way.

LIMITED WARRANTY – Subject to the terms and conditions below, Miller Electric Mfg. Co., Appleton, Wisconsin, warrants to its original retail purchaser that new Miller equipment sold after the effective date of this limited warranty is free of defects in material and workmanship at the time it is shipped by Miller. THIS WARRANTY IS EXPRESSLY IN LIEU OF ALL OTHER WARRANTIES, EXPRESS OR IMPLIED, INCLUDING THE WARRANTIES OF MERCHANTABILITY AND FITNESS.

Within the warranty periods listed below, Miller will repair or replace any warranted parts or components that fail due to such defects in material or workmanship. Miller must be notified in writing within thirty (30) days of such defect or failure, at which time Miller will provide instructions on the warranty claim procedures to be followed.

Miller shall honor warranty claims on warranted equipment listed below in the event of such a failure within the warranty time periods. All warranty time periods start on the delivery date of the equipment to the original end-user purchaser, and not to exceed one year after the equipment is shipped to a North American distributor or eighteen months after the equipment is shipped to an International distributor.

1. 5 Years Parts — 3 Years Labor
 - * Original Main Power Rectifiers Only to Include SCRs, Diodes, and Discrete Rectifier Modules
2. 3 Years — Parts and Labor
 - * Engine Driven Welding Generators
(NOTE: Engines are Warranted Separately by the Engine Manufacturer.)
 - * Inverter Power Sources (Unless Otherwise Stated)
 - * Plasma Arc Cutting Power Sources
 - * Process Controllers
 - * Semi-Automatic and Automatic Wire Feeders
 - * Smith 30 Series Flowgauge and Flowmeter Regulators (No Labor)
 - * Transformer/Rectifier Power Sources
 - * Water Coolant Systems (Integrated)
3. 2 Years — Parts
 - * Auto-Darkening Helmet Lenses (No Labor)
4. 1 Year — Parts and Labor Unless Specified
 - * Automatic Motion Devices
 - * CoolBelt and CoolBand Blower Unit (No Labor)
 - * External Monitoring Equipment and Sensors
 - * Field Options
(NOTE: Field options are covered for the remaining warranty period of the product they are installed in, or for a minimum of one year — whichever is greater.)
 - * Flowgauge and Flowmeter Regulators (No Labor)
 - * RFCS Foot Controls (Except RFCS-RJ45)
 - * Fume Extractors
 - * HF Units
 - * ICE/XT Plasma Cutting Torches (No Labor)
 - * Induction Heating Power Sources, Coolers
(NOTE: Digital Recorders are Warranted Separately by the Manufacturer.)
 - * Load Banks
 - * Motor Driven Guns (w/exception of Spoolmate Spoolguns)
 - * PAPR Blower Unit (No Labor)
 - * Positioners and Controllers
 - * Racks
 - * Running Gear/Trailers
 - * Spot Welders
 - * Subarc Wire Drive Assemblies
 - * Water Coolant Systems (Non-Integrated)
 - * Weldcraft-Branded TIG Torches (No Labor)
 - * Wireless Remote Foot/Hand Controls and Receivers
 - * Work Stations/Weld Tables (No Labor)
5. 6 Months — Parts
 - * Batteries
 - * Bernard Guns (No Labor)
 - * Tregaskiss Guns (No Labor)

6. 90 Days — Parts
 - * Accessory (Kits)
 - * Canvas Covers
 - * Induction Heating Coils and Blankets, Cables, and Non-Electronic Controls
 - * M-Guns
 - * MIG Guns and Subarc (SAW) Guns
 - * Remote Controls and RFCS-RJ45
 - * Replacement Parts (No labor)
 - * Roughneck Guns
 - * Spoolmate Spoolguns

Miller's True Blue[®] Limited Warranty shall not apply to:

1. **Consumable components; such as contact tips, cutting nozzles, contactors, brushes, relays, work station table tops and welding curtains, or parts that fail due to normal wear. (Exception: brushes and relays are covered on all engine-driven products.)**
2. Items furnished by Miller, but manufactured by others, such as engines or trade accessories. These items are covered by the manufacturer's warranty, if any.
3. Equipment that has been modified by any party other than Miller, or equipment that has been improperly installed, improperly operated or misused based upon industry standards, or equipment which has not had reasonable and necessary maintenance, or equipment which has been used for operation outside of the specifications for the equipment.

MILLER PRODUCTS ARE INTENDED FOR PURCHASE AND USE BY COMMERCIAL/INDUSTRIAL USERS AND PERSONS TRAINED AND EXPERIENCED IN THE USE AND MAINTENANCE OF WELDING EQUIPMENT.

In the event of a warranty claim covered by this warranty, the exclusive remedies shall be, at Miller's option: (1) repair; or (2) replacement; or, where authorized in writing by Miller in appropriate cases, (3) the reasonable cost of repair or replacement at an authorized Miller service station; or (4) payment of or credit for the purchase price (less reasonable depreciation based upon actual use) upon return of the goods at customer's risk and expense. Miller's option of repair or replacement will be F.O.B., Factory at Appleton, Wisconsin, or F.O.B. at a Miller authorized service facility as determined by Miller. Therefore no compensation or reimbursement for transportation costs of any kind will be allowed.

TO THE EXTENT PERMITTED BY LAW, THE REMEDIES PROVIDED HEREIN ARE THE SOLE AND EXCLUSIVE REMEDIES. IN NO EVENT SHALL MILLER BE LIABLE FOR DIRECT, INDIRECT, SPECIAL, INCIDENTAL OR CONSEQUENTIAL DAMAGES (INCLUDING LOSS OF PROFIT), WHETHER BASED ON CONTRACT, TORT OR ANY OTHER LEGAL THEORY.

ANY EXPRESS WARRANTY NOT PROVIDED HEREIN AND ANY IMPLIED WARRANTY, GUARANTY OR REPRESENTATION AS TO PERFORMANCE, AND ANY REMEDY FOR BREACH OF CONTRACT TORT OR ANY OTHER LEGAL THEORY WHICH, BUT FOR THIS PROVISION, MIGHT ARISE BY IMPLICATION, OPERATION OF LAW, CUSTOM OF TRADE OR COURSE OF DEALING, INCLUDING ANY IMPLIED WARRANTY OF MERCHANTABILITY OR FITNESS FOR PARTICULAR PURPOSE, WITH RESPECT TO ANY AND ALL EQUIPMENT FURNISHED BY MILLER IS EXCLUDED AND DISCLAIMED BY MILLER.

Some states in the U.S.A. do not allow limitations of how long an implied warranty lasts, or the exclusion of incidental, indirect, special or consequential damages, so the above limitation or exclusion may not apply to you. This warranty provides specific legal rights, and other rights may be available, but may vary from state to state.

In Canada, legislation in some provinces provides for certain additional warranties or remedies other than as stated herein, and to the extent that they may not be waived, the limitations and exclusions set out above may not apply. This Limited Warranty provides specific legal rights, and other rights may be available, but may vary from province to province.





Owner's Record

Please complete and retain with your personal records.

Model Name

Serial/Style Number

Purchase Date

(Date which equipment was delivered to original customer.)

Distributor

Address

City

State

Zip



For Service

Contact a DISTRIBUTOR or SERVICE AGENCY near you.

Always provide Model Name and Serial/Style Number.

Contact your Distributor for:

Welding Supplies and Consumables

Options and Accessories

Personal Safety Equipment

Service and Repair

Replacement Parts

Training (Schools, Videos, Books)

Technical Manuals (Servicing Information and Parts)

Circuit Diagrams

Welding Process Handbooks

To locate a Distributor or Service Agency visit www.millerwelds.com or call 1-800-4-A-Miller

Contact the Delivering Carrier to:

File a claim for loss or damage during shipment.

For assistance in filing or settling claims, contact your distributor and/or equipment manufacturer's Transportation Department.

Miller Electric Mfg. Co.

An Illinois Tool Works Company
1635 West Spencer Street
Appleton, WI 54914 USA

International Headquarters—USA

USA Phone: 920-735-4505 Auto-Attended
USA & Canada FAX: 920-735-4134
International FAX: 920-735-4125

For International Locations Visit
www.MillerWelds.com

